

TECHNICAL MANUAL MB250 HYDRO WOOD-PELLET STD 1 1

Revision Date	Description
09/11/2018	<ul style="list-style-type: none"> • Condition to enter Modulation and Standby in hydraulic plant 11 have been modified • Cleaning Engine and Cleaning Engine 2 in Check up have been added • Night Modality has been added • Parameter A25 has been added
14/09/2018	<ul style="list-style-type: none"> • Added Service, Cleaning, Working Hours, Ignition entries in Monitor Menu
24/07/2018	<ul style="list-style-type: none"> • Introduction of V14 parameter
12/07/2018	<ul style="list-style-type: none"> • Introduction of the Brazier Cleaning Engine in Check Up (P51 parameter) • Introduction of T25 timer. During this time exhaust fan2 works at power VS14 after transition from Pellet to Wood in Combi 2 modality • Introduction of A49 parameter in order to remove Buffer Thermostat management in Wood modality • Introduction of A51 enabling parameter for the management of Er02 error during Wood modality • The management of Thermostat L01 validation while decreasing has been modified during the Stabilization phase • Introduction of the Cleaning On message during periodic cleaning phase • Configuration 11 has been added
20/04/2018	<ul style="list-style-type: none"> • Boiler probe thermostat maximum range increased, NTC 231K probe added • Automatic Extinguishing function modified • Door management modified

1	INTRODUCTION	5
2	LANGUAGE PACKAGES.....	5
3	INSTALLATION	6
3.1	CONNECTIONS	6
3.2	FIRST CONFIGURATION	9
3.3	DIGITAL INPUTS.....	13
3.3.1	High Voltage1 (Safety Thermostat)	13
3.3.2	High Voltage 2 (Pressure Switch)	13
3.3.3	Encoder Auger	13
3.3.4	Encoder Combustion Fan	13
3.3.5	Grid Sensor.....	13
3.3.6	Door Sensor.....	13
3.3.7	Pellet Thermostat.....	13
3.3.8	Flow Switch	14
3.3.9	Room Thermostat	14
3.3.10	Pellet Level	14
3.3.11	Limit Switch Cleaning Engine	15
3.3.12	Limit Switch Cleaning Engine 2	15
3.3.13	Limit Switch Brazier Cleaning Engine	15
3.3.14	External Chrono	15
3.4	ANALOG INPUTS.....	15
3.4.1	Exhaust Probe (Thermocouple)	15
3.4.2	Boiler Probe.....	15
3.4.3	Buffer Probe / Top Buffer Probe	15
3.4.4	Bottom Buffer Probe.....	15
3.4.5	Boiler Return Probe / Flow	15
3.4.6	DHW Probe.....	16
3.4.7	External Probe	16
3.4.8	Water Pressure Sensor	16
3.4.9	Photo Resistance.....	16
3.4.10	Primary Air Flow or Vacuum Sensor	16
3.4.11	Room Probe.....	17
4	KEYBOARDS.....	18
4.1	LCD100	18
4.2	DISPLAY K100.....	18
4.3	DISPLAY K400.....	19
4.3.1	Home Page 1	19
4.3.2	Home Page 2	20
4.4	ERROR MESSAGES AND VIEWS	20
5	USER MENU	22
5.1	USER MENU 1.....	22
5.2	USER MENU 2.....	26
6	FUNCTIONING STATES.....	27
6.1	PELLET MODALITY	28
6.1.1	Off	28
6.1.2	Check Up.....	28
6.1.3	Ignition	28
6.1.4	Stabilization	30
6.1.5	Ignition Recovery	30
6.1.6	Run Mode.....	31
6.1.7	Modulation.....	32
6.1.8	Standby.....	33
6.1.9	Safety	35
6.1.10	Extinguishing	35
6.1.11	Block.....	36
6.2	WOOD MODALITY	36
6.2.1	Block and Off Wood	36

6.2.2	Wood Run Mode	36
6.2.3	Wood Modulation	37
6.2.4	Wood Standby	38
6.2.5	Wood Safety	38
6.2.6	Wood Extinguishing.....	38
6.3	COMBI MODALITY.....	40
7	OTHER FUNCTIONS	42
7.1	INTERNAL CHRONO MANAGEMENT.....	42
7.2	COMBUSTION STANDBY	42
7.3	AUTOMATIC COMBUSTION POWER.....	42
7.4	CHANGE POWER DELAY	42
7.5	SYSTEM MAINTENANCE 1 FUNCTION.....	42
7.6	SYSTEM MAINTENANCE 2 FUNCTION.....	43
7.7	FAST EXTINGUISHING	43
7.8	EXTINGUISHING IN IGNITION PHASE.....	43
7.9	AUTOMATIC SWITCH OFF FUNCTION.....	43
7.10	SUPPLY VOLTAGE LACK MANAGEMENT.....	43
7.11	AUGER FEEDING IN WOOD MODALITY.....	43
7.12	PERIODICAL CLEANING OF BRAZIER.....	44
7.13	CONFIGURABLE OUTPUTS MANAGEMENT	44
7.13.1	Safety Valve	44
7.13.2	Load Pellet Engine.....	44
7.13.3	Output under Thermostat	44
7.13.4	Cleaning Engine	44
7.13.5	Combustion Fan 2	45
7.13.6	Heating Fan	45
7.13.7	Air Valve.....	45
7.13.8	Error Signalling	45
7.13.9	Cleaning Engine 2	45
7.13.10	Auger 2 in On-Off mode	46
7.13.11	Auger 2 Always On	46
7.13.12	Air Valve 3.....	46
7.13.13	Air Valve 2.....	46
7.13.14	Mixer Valve	47
7.13.15	Pump P3	48
7.13.16	Brazier Cleaning Engine.....	48
7.13.17	Auger block.....	50
7.14	CLIMATIC FUNCTION	50
7.15	PRIMARY AIR FLOW SENSOR	50
7.16	HYDRO - AIR MODALITY.....	52
7.16.1	Air Exchanger Fan Management.....	52
7.16.2	Plumbing Plant Management.....	52
7.16.2.1.	Pump and Valve Anti-Lock Function.....	61
7.16.2.2.	Sanitary Function	61
7.16.2.3.	Pressure Sensor Selection	61
8	SYSTEM MENU PARAMETERS	62
8.1	AUGER MENU	62
8.2	COMBUSTION FAN MENU	62
8.3	COMBUSTION FAN 2 MENU	63
8.4	HEATING FAN MENU.....	63
8.5	THERMOSTATS MENU	64
8.6	TIMERS MENU	65
8.7	ENABLE MENU	67
8.8	PRIMARY AIR FLOW SENSOR MENU	69
8.9	WATER PRESSURE SENSOR THRESHOLD MENU	70
8.10	COUNTERS MENU	70
8.11	OUTPUT'S TEST MENU	70
8.12	RESTORE PARAMETER'S FACTORY VALUE MENU	71

1 INTRODUCTION

The MB250 Controller is a device to manage stoves and boilers with automatic ignition and pellet loading. The operation of the heating system is determined by reading the exhaust temperature, water temperature, and through the acquisition of the parameters setup by the user. The parameters of the controller are fully configurable inside the menu. By setting the parameters it is possible to:

- modify the operation of the heating system according to the user's specific requirements
- modify the operation of the controller to suit any stove or boiler

This manual illustrates in detail the controller installation steps, the configuration, the functioning and the technical characteristics.

2 LANGUAGE PACKAGES



Languages			
K100, K400 and K700 have the following languages available:			
Italian	Polish	Dutch	Latvian
Portuguese	Serbian	Danish	Estonian
German	Romanian	Swedish	Hungarian
French	Czech	Turkish	Lithuanian
Spanish	Russian	Greek	Slovak
English	Bulgarian	Croatian	Slovenian
LCD100 and LCD100 touch keyboards have the following languages available:			
<i>Set 1</i>	<i>Set 2</i>	<i>Set 3</i>	
English	English	English	
Italian	Slovenian	Turkish	
French	Serbian	Czech	
German	Romanian	Polish	
Spanish	Greek	Russian	
Portuguese	Hungarian	Bulgarian	

Firmware Codes			
<i>Control Board</i>			
MB250	FSYSD01000174		
<i>K Series Keyboard</i>			
K100	FSYSF04000027		
K400	FSYSF13000005		
K700	FSYSF18000005		
<i>LCD Series Keyboard</i>	<i>Set 1</i>	<i>Set 2</i>	<i>Set 3</i>
LCD100	FSYSF01000292	FSYSF01000293	FSYSF01000294
LCD100 Touch	FSYSF03000084	FSYSF03000085	FSYSF03000086

3 INSTALLATION

3.1 CONNECTIONS

In the below picture is showed the connections of the main board and its outputs and inputs. Follow the indications of the connection modalities for a correct installation.

	For a correct and secure functioning connect always ground connection
	For a correct operation follow carefully the modalities of connection indicated to avoid damage to electronics
	Make connection in a tidy way; keep separated cables of low voltage (probes, contacts, control panel flat) and cables of high voltage (power source, loads) to reduce interference problems

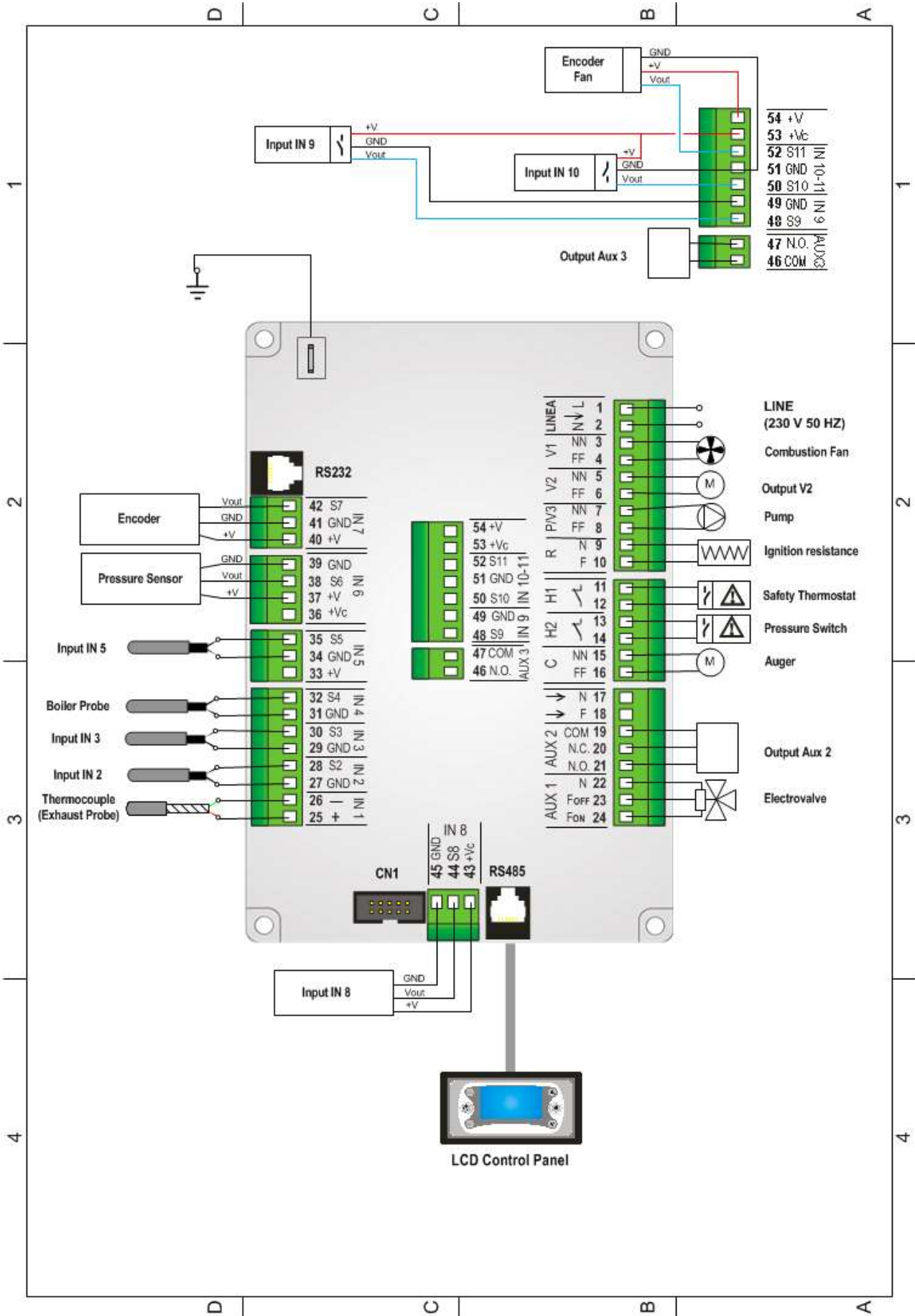

Pin	Function	Technical Specifications
1-2	Line	Version 230Vac ± 10% 50/60 Hz Version 110Vac ± 10% 50/60 Hz Fuse T 6,3 A
3-4	Combustion Fan	Triac, feeding output (Max 0.8 A)
5-6	Output V2 configurable Configuration parameter: P44	Triac, feeding output (Max 0.8 A)
7-8	Pump	Relay, feeding output (Max 3 A)
9-10	Ignition Resistance	Relay, feeding output (Max 3 A)
11-12	High Voltage 1 Input Short-circuit if not used	High voltage input, contact open/closed
13-14	High Voltage 2 Input Short-circuit if not used	High voltage input, contact open/closed
15-16	Auger Motor	Triac, feeding output (Max 0.5 CV)
17	-	Neutral
18	-	Phase
19-20-21	Output Aux2 configurable Configuration parameter: P48	Relay, free contact output (Max 3 A) 19: COM 20: N.C. 21: N.O.
22-23-24	Electrovalve	Relay, feeding output (Max 3 A) 22: N 23: F _{OFF} 24: F _{ON}
25-26	Exhaust Probe	Thermocouple K 25: Red (+) 26: Green (-)
27-28	Input IN2 configurable Configuration parameter: P74	Analog Input (NTC 10K probe)/Digital Input
29-30	Input IN3 configurable Configuration parameter: P75	Analog Input (NTC 10K probe)/Digital Input
31-32	Boiler Probe	Analog Input NTC 10K if PA44 =0 Analog Input NTC 231K if PA44 =1
33-34-35	Input IN5 configurable Configuration parameter: P76	Analog Input (NTC 10K probe)/Digital Input
36	Not used	-
37-38-39	Water Pressure Sensor	Analog Input
40-41-42	Encoder Sensor (see parameter A57)	40: +5V 41: GND 42: signal
43-44-45	Input IN8 configurable Configuration parameter: P71	43: +12V 44: signal 45: GND
46-47	Output Aux3 configurable Configuration parameter: P36	Relay, free contact output (Max 3 A) 47: N.O. 48: COM
48-49-53	Input IN9 configurable Configuration parameter: P70	48: signal 49: GND 53: +12V
50-51-53	Input IN10 configurable Configuration parameter: P73	50: signal 51: GND 53: +12V
51-52-54	Encoder Sensor (see parameter A57)	51: GND 52: signal 54: +5V
CN1	Local Keyboard Connection	-
RS232	Serial Port Connection	Serial Port RS232
RS485	Serial Port Connection	Serial Port RS485
	Connect to the Earth CONNECT ALWAYS	-

3.2 FIRST CONFIGURATION

First of all, set parameter **P42** to choose the Hydro or Air modality (see par. 7.15). If the Hydro modality is set, select the plumbing plant (parameter **P26** in the Default Settings Menu of the Technical Menu). Then set the configurable outputs via parameters of the Default Settings Menu **P44**, **P48** and **P36**, then set the parameters **P70**, **P71**, **P73**, **P74**, **P75** and **P76**. Finally set the parameters **P25** to choose the Combustion Fan type (with or without encoder) and **P81** to choose the Auger type (with or without encoder). Set also the parameter **PA44** to define the NTC probe to connect to input IN4.

Plumbing Plants (for more details see section 7.16.2):

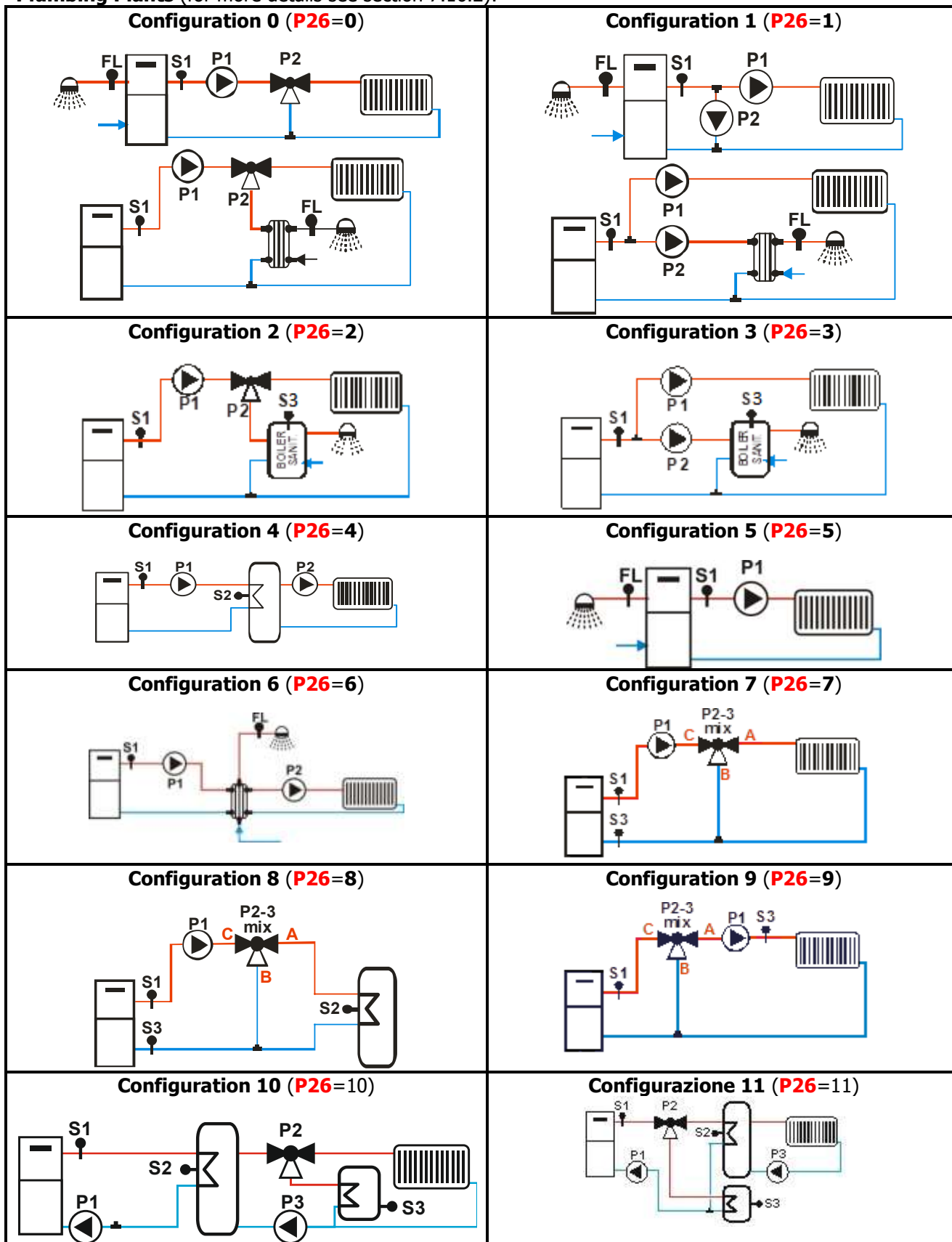

Whenever you select plant 10, properly shorting Puffer Probe Inputs (Probe S2) and ACS Probe (Probe S3), it is possible to select one of the following plant automatically:

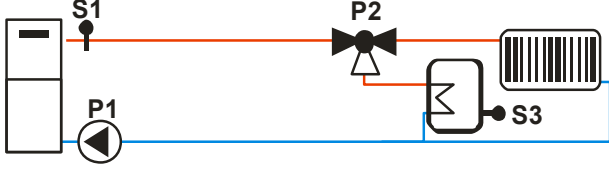
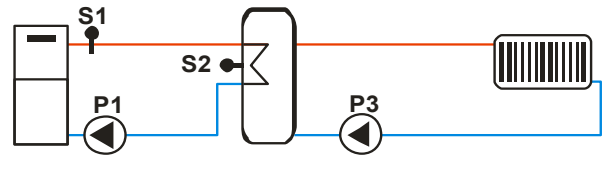
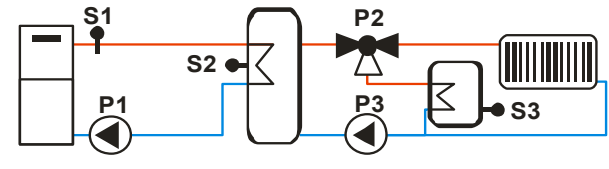
<i>Probe</i>	<i>Condition</i>	<i>Setted Plant</i>	<i>Probe</i>	<i>Condition</i>	<i>Setted Plant</i>
Puffer	Short circuit	Plant 5	Puffer	Short circuit	Plant 2
DHW	Short circuit		DHW	Probe	
 <p>P1 Pump: pins 7-8 To more details see the par. 7.16.27.16.2 - Plumbing Plant Management, Configuration 5.</p>			 <p>P1 Pump: pins 7-8, P2 Valve: Pins 22-24 To more details see the par. 7.16.2 - Plumbing Plant Management, Configuration 2.</p>		
Puffer	Probe	Plant 4	Puffer	Probe	Plant 10
DHW	Short circuit		DHW	Probe	
 <p>P1 Pump: pins 7-8, System Pump P3 To more details see the par. 7.16.2 - Plumbing Plant Management, Configuration 4. N.B. In paragraph 7.17 P3 Pump is identified as P2 Pump.</p>			 <p>Recirculation Pump P1: pins 7-8, P2 Valve: pins 22-24, System Pump P3 To more details see the par. 7.16.2 - Plumbing Plant Management, Configuration 10.</p>		

When the system detects a different input configuration error message **Er56**. For the actual setting of the system, if plant 10 is selected or the existing probes configuration is modified, follow this steps:

- set the parameters:
 - P26=10**
 - P74 or P75 or P76=8**
 - P74 or P75 or P76=9**
 - P36 or P44 or P48=14**
- put the system in Off state
- cut off the power
- make the appropriate changes to the inputs Buffer probe and DHW probe
- restore power
- control in Views menu if the temperature detected by the present probes coincides with the setting made
- repeat all operation from step one if necessary

Configurable Output (for more details see section 7.13):

<i>Connected Devices</i>	<i>Parameter Value</i>	<i>Output</i>		
		<i>V2 (P44)</i>	<i>Aux2 (P48)</i>	<i>Aux3 (P36)</i>
Output not used	0	√	√	√
Safety Valve (see 7.13.1)	1	√	√	√
Loading Engine (see 7.13.2)	2	√	√	√
Output under thermostat (see 7.13.3)	3	√	√	√
Cleaning Engine (see 7.13.4)	4	√	√	√
Combustion Fan 2 (see 7.13.5)	5	√	-	-
Heating Fan (see 7.13.6)	6	√	-	-
Air Valve (see 7.13.7)	7	√	√	√
Error Signalling (see 7.13.8)	11	√	√	√
Cleaning Engine 2 (see 7.13.9)	13	√	√	√
Pump P3	14	√	√	√
Auger 2 Pause-Work (see 7.13.10)	16	√	-	-
Auger 2 always On (see 7.13.11)	17	√	√	√

Air Valve 3 (see 7.13.12)	20	✓	✓	✓
Air Valve 2 (see 7.13.14)	22	✓	✓	✓
Mixer Valve (see 7.13.15)	23	-	-	✓
Brazier Cleaning Engine (see 7.13.16)	25	✓	✓	✓
Auger Block (see 7.13.17)	26	-	✓	✓
Brazier Cleaning Engine (direction) (see 7.13.16)	33	-	✓	-

The Aux2 output is a free contact output; in case it is necessary to use it to control a supplied load 230 Vac, follow the diagram below. If the output is activated, there is 230 Vac between the connectors 19-21.

If the output is deactivated, there is 230 Vac between the connectors 19-20.

Even the Aux3 output is a free contact output; in case it is necessary to use it to control a supplied load 230 Vac, follow the diagram below.

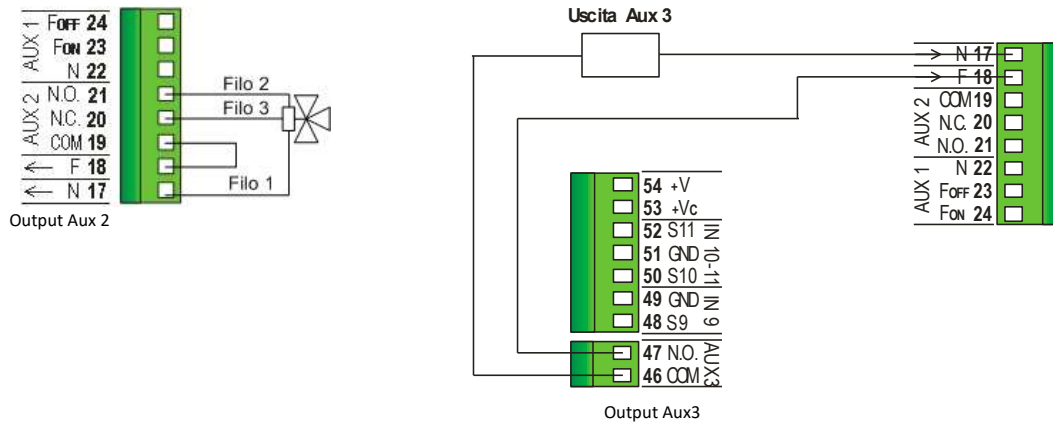

IN8 Configurable Input (for more details see sections 3.3 and 3.4):

Connected Devices	Parameter Value	Input
		IN8 (P71)
Input not used	0	✓
Primary Air Flow Sensor	1	✓
Pellet Level Sensor	2	✓
Photo resistance	3	✓

IN2, IN3, IN5, IN9 and IN10 Configurable Inputs (for more details see sections 3.3 and 3.4):

Connected Devices	Parameter Value	Input				
		IN2 (P74)	IN3 (P75)	IN5 (P76)	IN9 (P70)	IN10 (P73)
Input not used	0	✓	✓	✓	✓	✓
Grid Sensor	1	✓	✓	✓	✓	✓
Door Sensor	2	✓	✓	✓	✓	✓
Pellet Thermostat	3	✓	✓	✓	✓	✓
Room Thermostat	4	✓	✓	✓	✓	✓
Flowswitch	5	✓	✓	✓	✓	✓
Pellet Level Sensor	6	✓	✓	✓	✓	✓
External probe	7	✓	-	-	-	-
Return Boiler/Flow/DHW probe	8	-	✓	-	-	-
Buffer probe /High Buffer Probe	9	-	-	✓	-	-
Limit Switch Cleaning Engine	10	✓	✓	✓	✓	✓
Limit Switch Cleaning Engine 2	11	✓	✓	✓	✓	✓
Limit Switch Brazier Cleaning Engine	12	✓	✓	✓	✓	✓
Room Probe	15	✓	✓	✓	-	-
External Chrono	17	✓	✓	✓	✓	✓
Photo resistance	18	✓	✓	✓	-	-
Bottom Buffer probe	23	✓	✓	✓	-	-

NOTE

If a contact is connected on input IN10, it has to be connect to pins 50 and 53.

Keyboards links

The keyboards use the RS485 protocol for connection to the control board. This standard allows connections to long distances, with high noise immunity, provided that they comply with the directives of the protocol. It is therefore recommended to use shielded twisted pair wires for connection.

Remote Keyboard

The Remote Keyboard allows remote control of the system. It's functionality is similar to the Local Keyboard; on board is inserted a sensor for detecting the ambient temperature and the displayed temperature is sensed by said sensor.

Links

Below is shown how connect the Remote Keyboard to the SYPlug02 board that leads out of the stove or boiler the control board's RS232 and RS485 connectors.

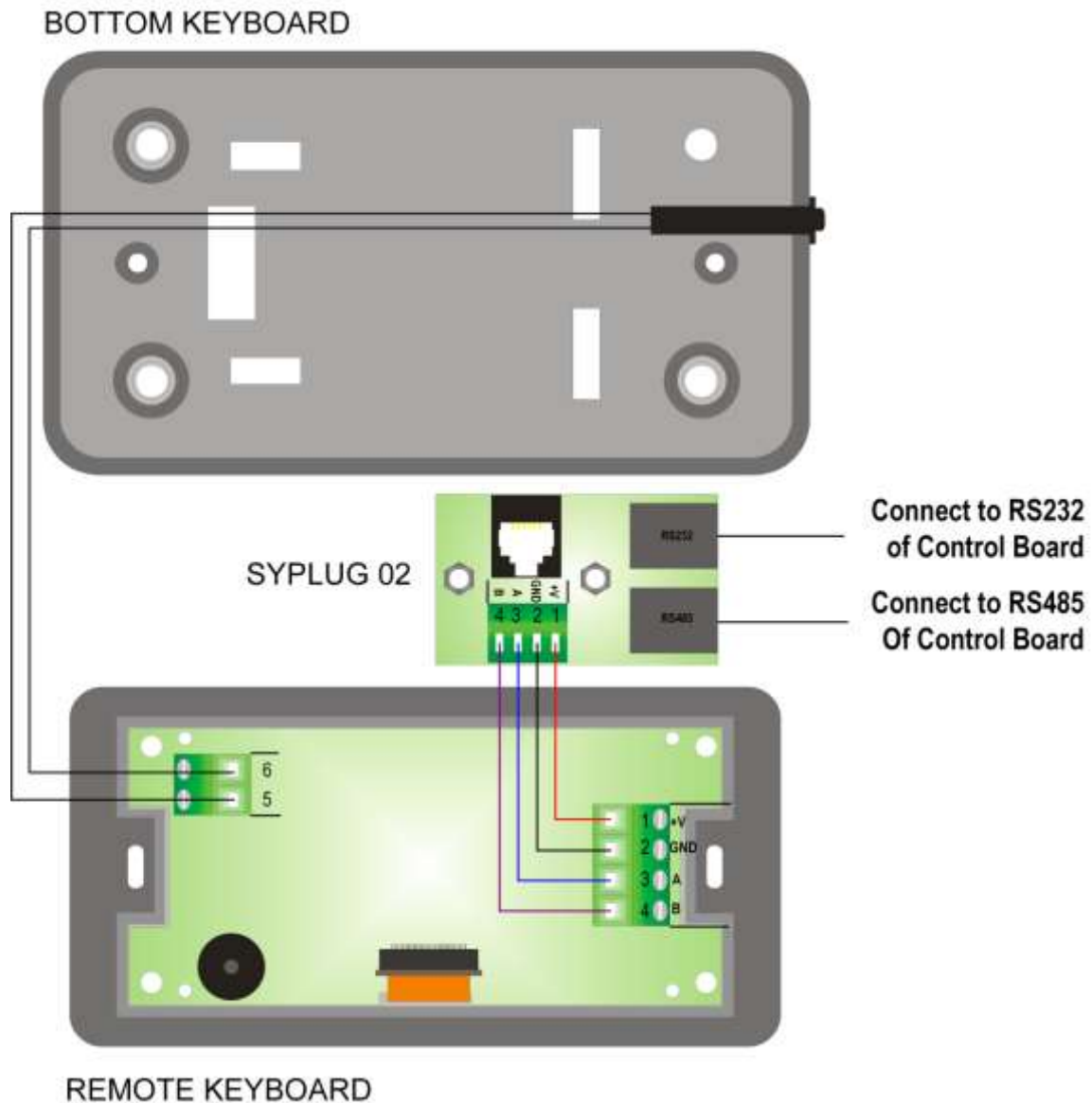

3.3 DIGITAL INPUTS

3.3.1 HIGH VOLTAGE 1 (SAFETY THERMOSTAT)

When the contact is opened in every functioning state, after a delay equal to timer **T09**, the system goes in Extinguishing and then in Block; the display visualises error High Voltage 1 Safety (**Er01**).

This input is suitable to connect a Manually Rearmed Thermostat; if the system does not use this input short-circuit Pins **11-12** of the connector.

3.3.2 HIGH VOLTAGE 2 (PRESSURE SWITCH)

When the contact is opened, after a delay equal to timer **T10**, the system goes in Extinguishing and then in Block; the display visualises error High Voltage 2 Safety (**Er02**). This management can be disabled during Wood Modality by setting **A51=0**.

The state of this input is not detected if the Combustion Fan is off.

This input is suitable to connect a Pressure Switch; if the system does not use this input short-circuit Pins **13-14** of the connector.

3.3.3 ENCODER AUGER

To the connections **40-41-42** you can connect an input to read the encoder signal in order to adjust rounds number of auger. Connect as showed in the table.

3.3.4 ENCODER COMBUSTION FAN

To the connections **40-41-42** or **51-52-54** you can connect an input to read the encoder signal in order to adjust rounds number of combustion fan. Connect as showed in the table.

3.3.5 GRID SENSOR

If the contact is closed and the system is in Pellet modality, the display shows the message **Er20**; if the system is in Off state, it isn't possible the ignition until the contact is opened. If the system is in Combo modality, at the time of switching to Pellet modality, if the contact is closed, the system goes in Off state and Pellet modality. In Wood modality the sensor status doesn't influence the system behavior.

If the input is set but not used, leave the pins unconnected.

3.3.6 DOOR SENSOR

In case of opening the door, on the panel appears the message '**Port**', the Augers turn off and the functioning of the Combustion Fans depends from the parameter **P96** value.

- **P96=0**: both Fans are blocked if the exhaust temperature is higher than the thermostat **Th01** in Pellet modality or **Th13** in Wood modality, in Block State or, if in a different state, independently from **Th01/Th13**.
- **P96=1**: Combustion Fan 1 goes to maximum speed and Combustion Fan 2 is blocked if the exhaust temperature is higher than the thermostat **Th01** in Pellet modality or **Th13** in Wood modality, in Block state or, if in a different State, independently from **Th01/Th13**.
- **P96=2**: Combustion Fan 1 is blocked and Combustion Fan 2 goes to maximum speed if the exhaust temperature is higher than the thermostat **Th01** in Pellet modality or **Th13** in Wood modality, in Block state or, if in a different State, independently from **Th01/Th13**.
- **P96=3**: both fans go to maximum speed if the exhaust temperature is higher than the thermostat **Th01** in Pellet modality or **Th13** in Wood modality, in Block state or, if in a different State, independently from **Th01/Th13**.
- **P96=4**: both fans go to a speed set by parameters **PA46** and **PA47** if the exhaust temperature is higher than the thermostat **Th01** in Pellet modality or **Th13** in Wood modality, in Block state or, if in a different State, independently from **Th01/Th13**.

In case of use of the Photoresistance and while the system is in OFF, while the door is open the reading of the light will be ignored.

If the door is open, the Timer **T21** resets.

In case in which the sensor is selected but not used, short circuit the corresponding pins of the board.

3.3.7 PELLET THERMOSTAT

When the contact switches on there is return of flame and until the contact is open, the display shows **Er06** and:

- if **P44**, **P36** or **P48** are equal to sixteen or seventeen (product with two Auger), the Auger is Off, the Auger 2 and fan combustion are always On.
- if **P44**, **P36** and **P48** are equal to one (product with Auger and Safety Valve), the Auger is Off, the combustion fan is off and the Safety Valve closes.
- if **P44**, **P36** and **P48** are different from one, sixteen and seventeen (product with one Auger), the Combustion Fan is always On, the Auger is On if **A44**=0, is Off if **A44**=1.

If the contact is opened in Ignition, the output heating resistance is turned off.

If the input is set but not used short circuit the relative pins.

3.3.8 FLOW SWITCH

To use a Flow Switch input set the parameter (**P26**=0, 1, 5, 6). Leave unconnected the pins if it is set but not used.

3.3.9 ROOM THERMOSTAT

Setting the parameter Enables **A01** it is possible to:

- if **A01** = 0
contact closed: the system goes in Ignition
contact open: the system goes in Extinguishing
This functioning is available only in Pellet or Combo modality, and P11 = 4 (Combi 2)
- if **A01** = 1
contact closed: the system goes in Run Mode
contact open: the system goes in Modulation
- if **A01** = 2
contact closed: the system goes in Run Mode
contact open: the system goes in Standby
- if **A01** = 3
contact closed: the system reactivates the Pump
contact open: if the temperature of the water exceeds the value of the Thermostat for the Activation of the System Pump (**Th19** or **Th59**), the system blocks the Pump until the temperature reaches the **Th21** or **Th78** Thermostat
- if **A01** = 4
contact closed: the system reactivates the Pump and goes in Run Mode
contact open: the system goes in Standby and blocks the Pump as in case 2 and 3
- if **A01** = 5
contact closed: the system goes in Run Mode
contact open: the system goes in Standby with Pellet, and in Modulation with Wood.
- if **A01** = 6
contact closed: the system reactivates the Pump
contact open: the system with Wood passes to Modulation, with Pellet if the temperature of the water exceeds the value of the Thermostat for the Activation of the System Pump (**Th19** or **Th59**), the system blocks the Pump until the temperature reaches the **Th21** or **Th78** Thermostat
- if **A01** = 7
contact closed: the system reactivates the Pump and goes in Run Mode
contact open: the system goes in Standby and blocks the Pump as in case 2 and 3 with Pellets, goes to Modulation with Wood.

NOTE:

If there is a sanitary water demand in Wood Mode, the Room Thermostat does not block the Pump and, if it was previously blocked by the Thermostat, it is reactivated. In plants 4 and 10 the Pump is blocked in Wood mode too.

If **A13**=2, on Summer all operations of Room Thermostat are disabled except for **A01**=0.

If **A01**=1, 2, 3, 4, 5, 6, 7 and the input is not used short circuit the relative pins.

3.3.10 PELLET LEVEL

Setting the parameters **P36**, **P44** and **P48** in the Technical Menu it is possible to:

- **P44**, **P48** and **P36** different from 2

If the level falls below the threshold, the system signals the lack of fuel for a time equal to the **T24**, then it goes in Extinguishing with error (**Er18**). If the tank is filled the system stops every signalling and it is possible to restart it.

This control is done only in Pellet modality.

- **P44=2 or P48=2 or P36=2**

If the level falls below the predetermined threshold, the output that controls the Load Pellet

Connection:

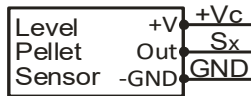

- +V of sensor to the pin 43 or 53
- -GND of sensor to the relative GND pin of the input set as Pellet Level
- Out of sensor to the relative pin Sx of the input set as Pellet Level

If a Pellet Level Sensor is connected with output in DC and the voltage is greater than 5v, connect it to the IN8 or IN9 input. These inputs can support voltage until 12V. Sensors with maximum output 5V, can be connected to every input. The temperature controller can support only Pellet Level sensors PNP type.

3.3.11 LIMIT SWITCH CLEANING ENGINE

Use the contact only if an output is set as Cleaning Engine.

3.3.12 LIMIT SWITCH CLEANING ENGINE 2

Use the contact only if an output is set as Cleaning Engine 2.

3.3.13 LIMIT SWITCH BRAZIER CLEANING ENGINE

Use the contact only if an output is set as Brazier Cleaning Engine.

3.3.14 EXTERNAL CHRONO

At the closure of contact, the system goes in Ignition, at the opening it goes in Extinguishing.

3.4 ANALOG INPUTS

3.4.1 EXHAUST PROBE (THERMOCOUPLE)

To the connections **25-26** is available the Exhaust Probe. With this probe, it is possible to read the exhaust temperature.

This probe is a Thermocouple K sensor. The sensor can read from 0 to 500°C with a precision of 1 °C. If you don't connect the probe to the system you'll read 900 °C.

NOTE: even if the sensor can read temperatures in the range 0 ÷ 500 °C the entire sensor wiring can work only in the range 0 ÷ 500 °C.

TiEmme elettronica is not responsible of any damage or bad functioning of the probe due to a wrong use of it (i.e. thermic and mechanical stresses to the probe).

3.4.2 BOILER PROBE

To the connections **31-32** is available the Boiler Probe. With this probe, it is possible to read the water temperature of the boiler. If you don't connect the probe to the system you'll read -50 °C, in case of short-circuit you'll read the maximum value.

3.4.3 BUFFER PROBE / TOP BUFFER PROBE

To use this input as a Probe set the parameter **P26=4, 8, 10, 11** and **P74, P75** or **P76=9**.

This probe is a NTC 10K sensor; it can read from -50 to 110°C with a precision of 1 °C. If you don't connect the probe to the system you'll read -50 °C. In case of short-circuit you'll read 110 °C.

3.4.4 BOTTOM BUFFER PROBE

To use this input as a Probe set the parameter **P26=4, 8, 10, 11** and **P74, P75** or **P76=23**.

If you don't connect the probe to the system you'll read -50 °C. In case of short-circuit you'll read 110 °C.

3.4.5 BOILER RETURN PROBE / FLOW

To use this input as a Probe set the parameter **P26=7, 8, 9** and **P74, P75** or **P76=8**.

This probe is an NTC 10K sensor and its range is -50÷110 °C with a precision of 1 °C. If you don't connect the probe to the system you'll read -50 °C, in case of short-circuit you'll read 110°C.

3.4.6 DHW PROBE

To use this input as a Probe set the parameter **P74**, **P75** or **P76**=8 and **P26**=2, 3, 10, 11.
This probe is an NTC 10K sensor and its range is 0 ÷ 110° C with a precision of 1 °C.
If you don't connect the probe to the system you'll read -50 °C, in case of short-circuit you'll read 110°C.

3.4.7 EXTERNAL PROBE

To use this input as a Probe set the parameter **P74**, **P75** or **P76**=7.
This probe is an NTC 10K sensor and its range is -50÷110 °C with a precision of 1 °C. If you don't connect the probe to the system you'll read -50 °C, in case of short-circuit you'll read 110°C.

3.4.8 WATER PRESSURE SENSOR

To the connections **37-38-39** is available the Pressure Sensor to read the boiler's pressure. It can read from 0 to 3000 mbar. To activate the alarms due over/under pressure of the boiler, set the parameter **A14**=1. In this case, set the minimum and maximum pressure levels (**SP01** and **SP08** parameters).

3.4.9 PHOTO RESISTANCE

The probe detects the flame brightness of the brazier. The brightness range goes from 0 to 100. If not connected the read value is 0. In case of use on input IN8 connect it to pin 44 (signal) and 33 (+5V).

The photo resistance is enabled only in Pellets modality. If the system provides a Wood modality it is necessary to use also the thermocouple.

3.4.10 PRIMARY AIR FLOW OR VACUUM SENSOR

Setting the parameter **P71** it is possible to choose the sensor to connect to the Input IN8.

If **P71**=1 it is possible to connect an Air Primary sensor or a Vacuum sensor; the sensor works on the combustion parameters (Auger and Combustion Fan). The range is 0÷2000.

In the case of disconnected probe the system will read a speed value of 0. In case of failure adjustment it shows the message **Er17**, in case of broken sensor or not connected properly, will appear the message **Er39**.

If an Air Primary sensor is used:

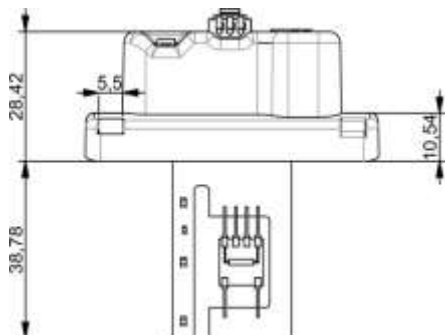

Connections:

- 43=+12V (red wire)
- 44=SEG (brown wire)
- 45=GND (black wire)

If a Vacuum sensor is used:

- has to be placed horizontally through the bracket supplied
- the connections for the pressure reading (see Figure 1 and 2) should be directed downward.

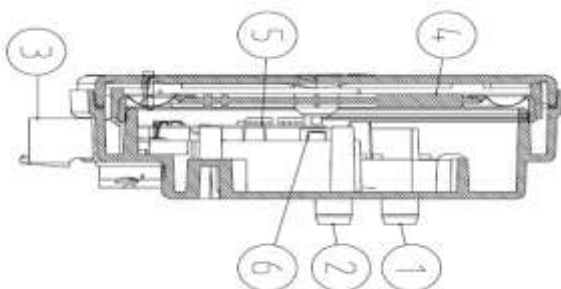

Connections:

- 43=+12V (red wire)
- 44=SEG (yellow wire)
- 45=GND (black wire)

Caption:

- 1 Connection pressure P1 (high pressure)
- 2 Connection pressure P2 (low pressure)
- 3. Electrical connections

3.4.11 ROOM PROBE

To use this input as a Probe set the parameter **P74**, **P75** or **P76**=15.

This probe is an NTC 10K sensor and its range is -50÷110 °C with a precision of 1 °C. If you don't connect the probe to the system you'll read -50 °C, in case of short-circuit you'll read 110°C.

Setting the parameter **A01** it is possible to:

thermostat not reached: the system goes in Ignition

thermostat reached: the system goes in Extinguishing

This functioning is available only in Pellet or Combo modality, and P11 = 4 (Combi 2)

- if **A01 = 1**
thermostat not reached: the system goes in Run Mode
thermostat reached: the system goes in Modulation
- if **A01 = 2**
thermostat not reached: the system goes in Run Mode
thermostat reached: the system goes in Standby
- if **A01 = 3**
thermostat not reached: the system reactivates the Pump
thermostat reached: if the temperature of the water exceeds the value of the Thermostat for the Activation of the System Pump (**Th19** or **Th59**), the system blocks the Pump until the temperature reaches the **Th21** or **Th78** Thermostat
- if **A01 = 4**
thermostat not reached: the system reactivates the Pump and goes in Run Mode
thermostat reached: the system goes in Standby and blocks the Pump as in case 2 and 3
- if **A01 = 5**
thermostat not reached: the system goes in Run Mode
thermostat reached: the system goes in Standby with Pellet, and in Modulation with Wood.
- if **A01 = 6**
thermostat not reached: the system reactivates the Pump
thermostat reached: the system in Wood modality passes to Modulation, in Pellet modality, if the temperature of the water exceeds the value of the thermostat for the activation of the System Pump (**Th19** or **Th59**), the system blocks the Pump until the temperature reaches the **Th21** or **Th78** Thermostat
- if **A01 = 7**
thermostat not reached: the system reactivates the Pump and goes in Run Mode
thermostat reached: the system goes in Standby and blocks the Pump as in case 2 and 3 with Pellets, goes to Modulation with Wood.

NOTE:

If there is a sanitary water demand in Wood Mode, the Room Thermostat does not block the Pump and, if it was previously blocked by the Thermostat, it is reactivated. In plants 4 and 10 the Pump is blocked in Wood mode too.

If **A13=2**, on Summer all operations of Room Thermostat are disabled except for **A01=0**.

If **A01=1, 2, 3, 4, 5, 6, 7** and the input is not used short circuit the relative pins.

4 KEYBOARDS

The keyboards of the system can be local (mounted on the machine) or remote (mounted outside of the machine), type of touch screen or LCD. The recognition by the baseboard of a keyboard, is via the communication address of the same keyboard. Program: address 16 for local key, address 17 for remote key

4.1 LCD100

The main frame shows:
time and date, chrono activation, combustion power, combustion recipe, system operating state, error code, main temperature, main thermostat, summer/winter modality, combi functioning

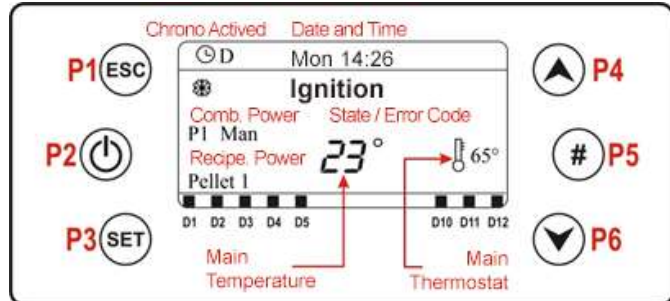

Button	Function		
P1	Exit menu and submenu		
P2	Ignition and extinguishing (push for 3 seconds), Reset errors (push for 3 seconds), Enable/disable chrono		
P3	Enter in User Menu 1/submenu, Enter in User Menu 2 (push for 3 seconds), Save data		
P4	Enter in Visualizations Menu, Increase		
P5	Enable chrono program, Change the operation mode of the system if P11 =2, 3, 4 (only in Off state)		
P6	Enter in Visualizations Menu, Decrease		
Led	Function	Led	Function
D1	Heating Resistance On	D7	Output Aux3 On
D2	Auger On	D8	-
D3	Pump On	D9	External Chrono reached
D4	Valve On	D10	Pellet Sensor signaling lack of material
D5	Output V2 On	D11	Room Thermostat reached
D6	Output Aux2 On	D12	DHW demand

4.2 DISPLAY K100

The main frame shows:
time and date, chrono activation, combustion power, heating power, system operating state, error code, main temperature, main thermostat

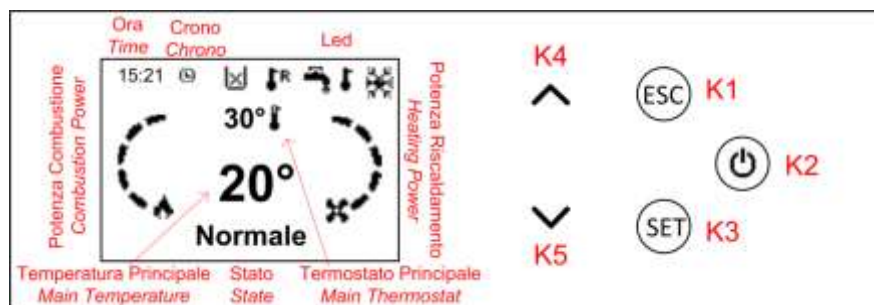



Button	Function		
K1	Exit Menu/Submenu		
K2	Ignition and extinguishing (push for 3 seconds), Reset errors (push for 3 seconds), Enable/disable chrono		
K3	Enter in User Menu 1/submenu, Enter in User Menu 2 (push for 3 seconds), Save data		
K4	Enter in Visualizations Menu, Increase		
K5	Enter in Visualizations Menu, Decrease		
Led	Function	Led	Function
	Room Thermostat reached	L1	External Chrono reached
	Winter		Summer
	Pellet Modality/Wood Modality		Combi Modality On







4.3 DISPLAY K400

The K400 control panel allows to move between screens with the horizontal or vertical swipe. The symbols near the following pictures point out the possibility to move with the swipe in that screen.

4.3.1 HOME PAGE 1



<p>The home page is composed of two pages: Date and time, main temperature, main thermostat, warning alarms tool</p>	 <p>HOMEPAGE 1/2</p>	
--	---	--









Home page buttons

	System ignition and unblock		Access to Visualizations menu
	Access to User menu 1		Access to chrono function
	Access to User menu 2		Access to the error list (64 errors recorded)

Main Led

The arrow in the main screen allows to access the toolbar where the system special led are located. The followings are available:

		
---	---	--

	combustion power set		Chrono state		Winter
	Summer		Wood		Pellet
	System functioning		Climatic function		

4.3.2 HOME PAGE 2

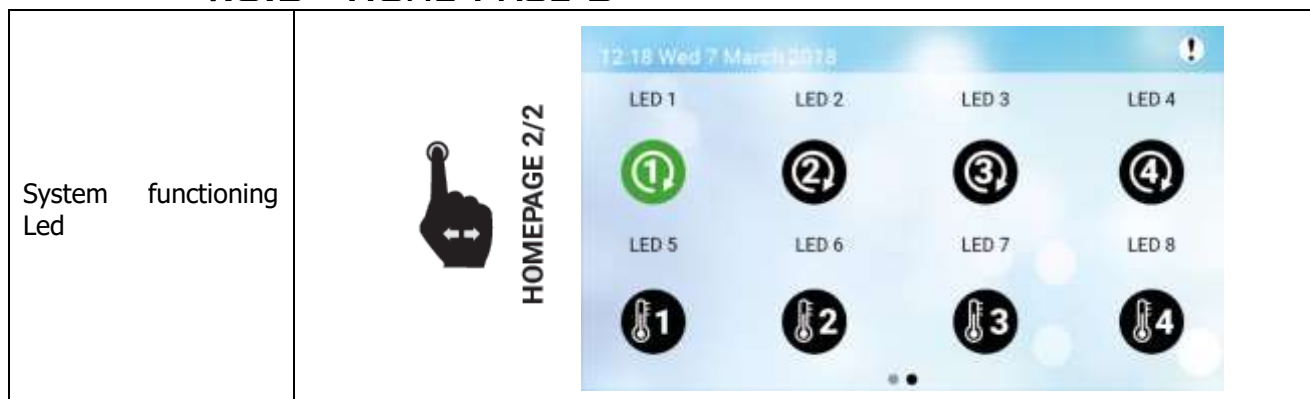

System functioning Led					
	Auger On		Igniter On		Pump On
	Valve ON		Output V2 ON		Aux2 output On
	Aux3 output On		External Chrono reached		Lack of material
	Room thermostat reached		DHW request		

4.4 ERROR MESSAGES AND VIEWS

Both the keyboard touch screen and LCD you can view the messages on the main screen such as error messages.

-Errors:

All errors make the security system block except errors **Er04** and **Er05** to wood.

Er01	Security Error High Voltage 1. It may also intervene with the system off.
Er02	Security Error High Voltage 2. It can only intervene if the fan Combustive is active.
Er03	Extinguishing for low exhaust temperature or missing light in the brazier
Er04	Shutdown over temperature water
Er05	Extinguishing due to high exhaust temperature
Er07	Encoder Error. The error may occur due to lack signal Encoder
Er08	Encoder Error. The error can occur due to problems of adjustment of the number of revolutions
Er09	Water pressure low
Er10	Water pressure high
Er11	Clock Error. The error occurs due to problems with the internal clock.
Er12	Extinguishing for ignition failure.
Er15	Extinguishing due to power failure for more than T89 minutes
Er16	RS485 communication error
Er17	Adjusting the Air Flow Failed
Er18	Exhaustion Pellet
Er23	Boiler probe or Back boiler probe or probe Buffer open
Er25	Engine cleaning brazier broken
Er26	Engine cleaning broken
Er27	Engine cleaning 2 broken
Er39	Sensor Flowmeter broken
Er41	Minimum air flow in Check Up is not reached
Er42	Maximum air flow exceeded (F40)
Er47	Error Encoder Auger: missing signal Encoder (if P81=1 or 2)
Er48	Error Encoder Auger: Auger regulation speed not achieved (if P81=1 or 2)

Er52	Error Module I/O I2C
Er56	Plumbing plant modified

-Other Messages:

Sond	Displaying the status of the Temperature Sensors. The message is displayed during the check-up and indicates that the temperature reading on one or more probes is equal to the minimum value or the maximum value (depending on the probe considered). Check that the probes are not open (read the minimum value of the temperature scale) or short (read the maximum value of the temperature scale).
Service	Message that signals the achievement of scheduled operating hours (parameter T66). It's necessary to call for service.
Clean	Message that signals the achievement of scheduled operating hours (parameter T67). It's necessary to clean the stove or boiler.
Ignition Block	Message that appears if the system is not manually turned off during Power On (after preload): the system will turn off only when it is arrived at running.
Er20	Sensor Grid closed with system in operation Pellets
Port	Door open.
Er06	Thermostat Pellet open.
Link Error	Lack of communication between keyboard and control board
Cleaning On	The system is performing Periodic Cleaning
Night Mode	The system goes into Night Mode
Msg!	LCD or K Series keyboards with missing translations. To cancel the message you have to upgrade the keyboard firmware.

-Monitor:

To access press **P4/P6** on LCD panel

Exhaust T.	Exhaust temperature [°C]
Light Flame	Light Flame [nr] (visible only if P71 =3 or P74, P75, P76 =18)
Boiler T.	Boiler temperature [°C]
Boiler Return T.	Boiler temperature [°C] (visible only if P74, P75, P76 =8)
Buffer T.	Buffer temperature [°C] (visible only if P42 =0 and P26 =2, 3, 4, 8, 10, 11)
Bottom Buffer T.	Bottom Buffer temperature [°C] (visible only if a configurable input is set to 23, P42 =0 and P26 =4, 8, 10,11)
DHW T.	Domestic Buffer temperature [°C] (visible only if P26 =2, 3, 10 and P42 =0)
Room T.	Room temperature [°C] (visible only if a configurable input is set to 15)
External T.	External temperature [°C] (visible only if a configurable input is set to 7)
Pressure	Pressure [mbar] (visible only if P42 =0)
Air flow	Air Flow [cm/s] (visible only if P71 =1)
Fan speed	Combustion Fan speed [RPM] (visible only if P25 =1, 2)
Auger	Auger work time [s] (visible only if P81 =0)
Service	Remaining hours before the system shows the message 'Service'
Cleaning	Remaining hours before the system performs the stove cleaning; it is displayed if T67 is greater then 0.
Working Hours	Working Hours of the stove in Run Mode, Modulation and Safety
Ignitions	Number of Ignition Attempts
Product Code 549	Product Code

5 USER MENU

5.1 USER MENU 1



To access the menu press **P3** or **K3** for the LCD keyboard.

Combustion Management *	Functioning Menu that allows to change the behaviour of the system, i.e. to switch from Wood to Pellet modality and vice versa or to select the Combi modality. The Menu is visible only if P11 =2, 3, 4. It is possible to change the functioning modality only if: <ul style="list-style-type: none"> • from the state of OFF, you can select any one of the three options • with system On and P11=2, the operation cannot be changed • with system On and P11=3, from the function only Wood you can move on to the Combi • with system On and P11=4, from the function only Wood/Pellet you can move on to the Combi. 						
	Pellet Power This Menu allows to set the system's combustion in automatic or manual mode in Pellet modality. If the manual mode is set, the user can choose the combustion power. The power change from 1 to the parameter P03 . This menu is visible only if P11 is different from 1.						
	Wood Power This Menu allows to set the system's combustion in automatic or manual mode in Wood modality. If the manual mode is set, the user can choose the combustion power. The power change from 1 to the parameter P03 . It is visible only if A36 =1 and P11 is different from 0.						
	Pellet Recipe Menu to select the combustion recipe in Pellet modality. The maximum value is the number of recipes visible to the user (parameter P04). This value can be set in the Secret Menu->Enables. If P04 =1 or P11 =1 the menu isn't visible.						
	Auger Calibration Menu to change the Auger's work time or speed. The system has 10 calibration's steps (0 value is set by the factory). The calibration's effect is valid only in Run Mode and Modulation for the current recipe. For each step the value is increased or decreased of a per cent value P15 set in the Default Settings Menu. This menu is visible only if P11 is different from 1 and A64 =1. <i>Example Auger calibration without encoder (P81=0): P15=10%, Step= -1</i>						
	Default Values	C03 =2,0	C04 =3,0	C05 =4,0	C06 =5,0	C07 =6,0	C11 =1,0
	Calibrated Values	C03 =1,8	C04 =2,7	C05 =3,6	C06 =4,5	C07 =5,4	C11 =0,9
	The calibrated values fall within the range defined by P27 and P05 parameters. <i>Example Auger calibration with encoder (P81=1, 2): P15=10%, Step= -1</i>						
	Default Values	C03 =1200	C04 =1300	C05 =1400	C06 =1500	C07 =1600	C11 =1000
	Calibrated Values	C03 =1320	C04 =1430	C05 =1540	C06 =1650	C07 =1760	C11 =1100
Fan Calibration Menu to change the Combustion Fan speed. The system has 10 calibration's steps (the 0 value is set by the factory). The calibration's effect is valid only in Run Mode and Modulation for the current recipe. For each step the value is increased or decreased of a per cent value P16 set in the Combustion Fan Menu. This menu is visible only if P11 is different from 1 and A64 =1. <i>Example: P16=5%, Step= +3</i>							
Default Values	U03 =1000	U04 =1200	U05 =1400	U06 =1600	U07 =1800	U11 =900	
Calibrated Values	U03 =1150	U04 =1380	U05 =1610	U06 =1840	U07 =2070	U11 =1030	

Heating Management*	<p>Boiler Thermostat</p> <p>Menu which allows to modify the Boiler Thermostat's value. It is possible to program the minimum and the maximum value of the Boiler Thermostat setting the Th26 and Th27 Thermostats.</p> <p>If the climatic function is enable (P74, P75, P76=7 and activation by user) this menu is not visible, because the value of the thermostat is automatically calculated by the system.</p>
	<p>Buffer Thermostat</p> <p>Menu which allows to modify the Buffer/Top Buffer Thermostat's value. This Menu is visible only if P42=0 and a plumbing plant with a Buffer Probe (parameter P26=4, 8, 10, 11) is set.</p> <p>It is possible to program the minimum and the maximum value of the Thermostat setting the Th51 and Th52 Thermostats. If the climatic function is enable (P74, P75, P76=7 and activation by user) and P26=4, 8 it isn't possible to modify the value of this thermostat, because the value is automatically calculated by the system.</p>
	<p>Bottom Buffer Thermostat</p> <p>Menu which allows to modify the Bottom Buffer Thermostat's value. This Menu is visible if an input is set as Bottom Buffer probe is set, P42=0 and P26=4, 8, 10, 11.</p> <p>It is possible to program the minimum and the maximum value of the Thermostat setting the Th51 and Th52 Thermostats</p>
	<p>DHW Thermostat</p> <p>Menu which allows to modify the Domestic Buffer Thermostat value. This Menu is visible only setting the parameter P42=0 and P26=2, 3, 10, 11. The maximum value can be programmed by setting Th83 Thermostat.</p>
	<p>Flow Thermostat</p> <p>Menu which allows to modify the Flow thermostat's value. This Menu is visible only if P42=0 and setting a plumbing plant with Flow Probe (P26=9).</p> <p>It is possible to program the minimum and the maximum value of the Thermostat setting the Th71 and Th72 Thermostats. If the climatic function is enable (P74, P75, P76=7 and activation by user) it isn't possible to modify the value of this thermostat, because the value is automatically calculated by the system.</p>
	<p>Room Thermostat</p> <p>Menu which allows to modify the Room Thermostat's value. It is visible if an input is set as Room probe.</p>
	<p>Heating Power</p> <p>It allows to change the heating fan's power. You can set the management of the heating system in automatic or manual mode. If the automatic mode is set, the power is regulated according P06 value. The power changes from 1 to P03. If P95=0 it is possible to stop the fan. This menu is visible only if P44=6 and A04=0.</p>
	<p>Summer-Winter</p> <p>Menu to modify the plumbing plant functioning according to the season. It is visible only if P42=0.</p>
	<p>Climatic Function</p> <p>Menu to manage the climatic function: it has 2 submenu, Enable and Comfort Function. It is visible only if P74, P75 o P76=7. The Enable submenu allows to the user to enable/disable the function; the Comfort submenu allows to correct the calculated thermostat by ± 20 °C. The climatic function is only in winter modality. If the function is enable, the display shows the symbol .</p>
	<p>Mixer Valve</p> <p>Menu to manage the Mixer Valve. It is possible to regulate it in automatic mode (see section 7.13.14) or force it to open or close (both for a time twice the parameter T82). It is visible only if P26=7, 8.</p>

Night Mode	<p>This Menu allows you to set and enable the time slots for the night mode starting and ending.</p> <p>The time slots set is the same as the one shown in the Chrono Menu. For a programming across midnight please set a time slot end to 23.59 and the following starting from 00.00 up to the time of your choice.</p> <p>The night mode allow you to disable, inside the set time slots, the operation of the following engines: Loading Engine (if PA53=1), Cleaning Engine (if PA54=1), Cleaning Engine 2 (if PA55=1), Brazier Cleaning Engine (if PA56=1).</p> <p>During the set times, the display shows the message <i>Night Mode</i>.</p> <p>The menu is displayed only if at least one engine is disabled in <i>Night Mode</i>.</p>
Remote Keyboard** (visible if A52 >0)	<p>Enable Thermostat It allows to enable/disable the Room Thermostat.</p> <p>Room Thermostat Menu to modify the r emote keyboard Room Thermostat.</p>
Load*	<p>This menu allows loading manually the Auger. The system has to be in Off state to do the loading. To close the Pressure switch contact, when the Auger starts to work, also the Exhaust Fan is activated.</p>
Cleaning Reset *	<p>This menu allows to reset the message of Function System Maintenance 2. It is visible only if T67>0.</p>
Chrono (for LCD100 and	<p>Menu to select the Chrono's program modality and the timers of Ignition/Extinguishing of the stove.</p>

<p>K100 keyboards)</p>	<p>Modality It allows selecting the disired modality, or disable all set programming.</p> <ul style="list-style-type: none"> • enter modification mode through the key P3 or K3 • select the chosen modality (Daily, Weekly or Week end) • enable/disable chrono modality through the keys P2 or K2 <p>save the settings through the keys P3 or K3</p> <p>Programming The system includes three type of programming: Daily, Weekly, Week end. After selecting the desired kind of programming:</p> <ul style="list-style-type: none"> • select the programming time through the keys P4/P6 or K4/K5 • enter the adjustment modality (selected time will be flashing) through the keys P3 or K3 • change the time via keys P4/P6 or K4/K5 • save the programmong with the keys P3 or K3 • enable (a "V" is displayed) or disable the time slot (a "V" is not displayed") by pressing the keys P5 or K2 <p style="text-align: center;"><i>Daily</i></p> <p>Select the day of the week to program and set the ignition and extinguishing times.</p> <p style="text-align: center;"><i>Programs around midnight</i></p> <p>Set the clock On of the previous day at the desired time: Ex. 20.30</p> <p>Set the clock of OFF of the previous day at: 23:59</p> <p>Set the clock On of the following day at 00:00</p> <p>Set the clock of OFF of the following day at the desired time: Ex. 6:30</p> <p>The system turns on at 20.30 on Tuesday and turns off at 6.30 on Wednesday</p> <p style="text-align: center;"><i>Weekly</i></p> <p>The programs are the same for all days of the week.</p> <p style="text-align: center;"><i>Week-end</i></p> <p>Choose between 'Monday-Friday' and 'Saturday-Sunday' and then set the switching on and off times.</p>	<div style="border: 1px solid black; padding: 5px; margin-bottom: 10px;"> Disabled Daily Weekly Week End </div> <div style="border: 1px solid black; padding: 5px; margin-bottom: 10px;"> Monday Tuesday Wednesday Thursday Friday </div> <div style="border: 1px solid black; padding: 5px; margin-bottom: 10px;"> <table border="1" style="width: 100%; border-collapse: collapse;"> <thead> <tr> <th colspan="2" style="background-color: black; color: black;">Monday</th> </tr> <tr> <th style="width: 50%;">ON</th> <th style="width: 50%;">OFF</th> </tr> </thead> <tbody> <tr> <td>09:30</td> <td>11:15 ↘</td> </tr> <tr> <td>00:00</td> <td>00:00</td> </tr> <tr> <td>00:00</td> <td>00:00</td> </tr> </tbody> </table> </div> <div style="border: 1px solid black; padding: 5px;"> Mon-Fri Sat-Sun </div>	Monday		ON	OFF	09:30	11:15 ↘	00:00	00:00	00:00	00:00
Monday												
ON	OFF											
09:30	11:15 ↘											
00:00	00:00											
00:00	00:00											

Chrono (for K400 keyboard)	<p>The chrono function allows to select and enable the desired programming mode for the system ignition and extinguishing.</p> <p>The system has three different programs</p> <ol style="list-style-type: none"> 1. Daily 2. Weekly 3. Weekend <p>Click the button  to access the programming.</p>	 <table border="1" data-bbox="1110 349 1437 528"> <thead> <tr> <th colspan="2">Scheduling</th> </tr> </thead> <tbody> <tr> <td>Monday</td> <td>03:15 - 04:30</td> </tr> <tr> <td>Tuesday</td> <td>09:00 - 11:30</td> </tr> <tr> <td>Wednesday</td> <td>21:15 - 23:30</td> </tr> </tbody> </table>	Scheduling		Monday	03:15 - 04:30	Tuesday	09:00 - 11:30	Wednesday	21:15 - 23:30
Scheduling										
Monday	03:15 - 04:30									
Tuesday	09:00 - 11:30									
Wednesday	21:15 - 23:30									

* only for local keyboard

** only for remote keyboard

5.2 USER MENU 2

To access the menu press **P3** or **K3** for the LCD keyboard.

Keyboard Setting	<p>Time and Date Used to set the day, month, year and current time.</p> <p>Language Menu to modify the keyboard language.</p>																								
Display Menu	<p>Brightness *** Menu used to regulate the display brightness.</p> <p>Contrast ** Menu used to regulate the display contrast.</p> <p>Minimum Light ** Menu used to regulate the lighting of the display when the command aren't used.</p> <p>Reboot control panel *** Menu that allows to reboot the control panel software.</p> <p>Sound It allows to enable or disable the acoustic alarm of the keyboard.</p> <p>Keyboard Address This menu is password-protected (the password is 1810); it allows to change the address of the RS485 node. In the RS485 bus it is not possible to have more nodes with the same address. It is possible to configure the keyboard as local or remote by changing the address (16 for local , 17 for remote)</p> <p>Wallpaper *** Menu that allows to select the control panel wallpaper.</p> <p>Node List This menu shows: communication address of the board, typology of the board, firmware code and firmware version. Data are not modifiable. The typologies of board that can appear are:</p> <table border="1" data-bbox="387 1559 1442 1619"> <thead> <tr> <th>Code</th> <th>Typology</th> <th>Code</th> <th>Typology</th> <th>Code</th> <th>Typology</th> <th>Code</th> <th>Typology</th> </tr> </thead> <tbody> <tr> <td>MSTR</td> <td>Master</td> <td>INP</td> <td>Input</td> <td>KEYB</td> <td>Keyboard</td> <td>OUT</td> <td>Output</td> </tr> <tr> <td>CMPS</td> <td>Composite</td> <td>SENS</td> <td>Sensor</td> <td>COM</td> <td>Communication</td> <td></td> <td></td> </tr> </tbody> </table> <p>Acoustic Alarm ** It allows to enable or disable the acoustic alarm of the keyboard.</p>	Code	Typology	Code	Typology	Code	Typology	Code	Typology	MSTR	Master	INP	Input	KEYB	Keyboard	OUT	Output	CMPS	Composite	SENS	Sensor	COM	Communication		
Code	Typology	Code	Typology	Code	Typology	Code	Typology																		
MSTR	Master	INP	Input	KEYB	Keyboard	OUT	Output																		
CMPS	Composite	SENS	Sensor	COM	Communication																				
System Menu *	<p>Menu to enter into technical menu. The access is protected by password (<i>default password: 0000</i>). See chapter 8 for more details.</p>																								

* only for local keyboard

** only for LCD keyboard

*** only for K400 keyboard

6 FUNCTIONING STATES

The functioning of the controller is managed with functioning states, each one is characterised by the control of the system's main functioning parameters, such as the exhaust temperature, the room temperature, security intervention and operating errors occurring.

- **Functioning states in Pellet Modality**

Off, Check Up, Ignition, Stabilization, Recover Ignition, Run Mode, Modulation, Standby (Extinguishing or Maintenance), Safety, Extinguishing, Block

- **Functioning states in Wood Modality**

Off, Run Mode, Modulation, Standby (Extinguishing or Maintenance), Safety, Extinguishing, Block

NOTE:

The system guarantees the security and alarms reading in each state.

If the parameter **A27**=1 and Safety High Voltage 1 contact (Safety Thermostat, pin 11-12) is open, the augers and the fans are disabled and the system goes into Extinguishing with error message **Er01**.

If **A27**=1 and the boiler water temperature exceeds the Boiler Thermostat **Th24**, in Extinguishing and Recovery Ignition the augers and the fans are disabled.

6.1 PELLET MODALITY

6.1.1 OFF

Timer		Control Thermostats		Combustion		Heating Resistance
				Fan	Auger	
	P71≠3 and P74,P75,P76≠18	exhaust temp.> Th01 Thermostat	→ goes in Extinguishing if the system was previously in Pellet modality	OFF	OFF	OFF
	P71=3 or P74,P75,P76=18	Light Flame > L00 Thermostat				
		water temp.>Thermostat Th25	→ goes in Block			

6.1.2 CHECK UP

Timer		Control Thermostats		Combustion		Heating Resistance
				Fan	Auger	
T01	P71≠3 and P74,P75,P76≠18	Si exhaust temp.> Th09 and previously the system was in Pellet Mode	→ goes in Run Mode	Max speed	OFF	OFF
	P71≠3 and P74,P75,P76≠18	Si exhaust temp.> Th01 and previously the system was in Wood or Combi Mode	→ goes in Ignition Recovery			
	P71=3 or P74,P75,P76=18	If Light flame > Thermostat L01	→ goes in Run Mode			
		If Water Temp. > (Boiler Thermostat-Ih24) and A27=0	→ goes in Standby			
		Control when T01 expires	→ goes in Ignition			

6.1.3 IGNITION

The state has some sub-phases and the current one is saved by the system.

Preheating

Timer		Control Thermostats		Combustion		Heating Resistance
				Fan	Auger	
T02	P71≠3 and P74,P75,P76≠18	exhaust temp.> Th09 Thermostat	→ goes in Run Mode	U01	OFF	ON
	P71=3 or P74,P75,P76=18	Light flame > L01 Thermostat	→ goes in Run Mode			

Preload

Timer		Control Thermostats		Combustion		Heating Resistance
				Fan	Auger	
T03	P71≠3 and P74,P75,P76≠18 P71=3 or P74,P75,P76=18	exhaust temp.> Th09 Thermostat	→ goes in Run Mode	U01	Always ON	ON
		Light flame > L01 Thermostat	→ goes in Run Mode			

NOTE: the timer **T03** passed is saved by the system

Fixed

Timer		Control Thermostats		Combustion		Heating Resistance
				Fan	Auger	
T04	P71≠3 and P74,P75,P76≠18 P71=3 or P74,P75,P76=18	exhaust temp.> Th09 Thermostat	→ goes in Run Mode	U01	C01	ON
		During the phase the exhaust temperature minimum value is saved by system				
		At the end of T04 if light flame > L01 Thermostat	→ goes in Stabilization			
		At the end of T04 if light flame < L01 Thermostat	→ goes in Variable Phase			

Variable

Timer		Control Thermostats		Combustion		Heating Resistance
				Fan	Auger	
T05	P71≠3 and P74,P75,P76≠18	exhaust temp.> Th09 Thermostat	→ goes in Run Mode	I Ignition: U01 II Ignition: U10	I Ignition: C01 II Ignition: C10	OFF if exhaust temp.> Th02 otherwise ON
		exhaust temp.> Th06 Thermostat and exhaust temp.>minimum value saved during the phase+ D41	→ goes in Stabilization			
		At the end of T05 if exhaust temp.< Th06 Thermostat or exhaust temp.<minimum value saved during the phase + D41	Retry Ignition from the Variable Phase; in case of ignition attempts are over, it goes in Extinguishing with alarm Er12			
	P71=3 or P74,P75,P76=18	Light flame > L01 Thermostat	→ goes in Stabilization			
	At the end of T05 if light flame < L01 Thermostat	Retry Ignition from the Variable Phase; in case of ignition attempts are over, it goes in Extinguishing with alarm Er12				

6.1.4 STABILIZATION

Timer		Control Thermostats		Combustion		Heating Resistance
				Fan	Auger	
T06	P71≠3 and P74,P75,P76≠18	exhaust temp.> Th09 Thermostat	→ goes in Run Mode	U02	C02	OFF if exhaust temp.> Th02 otherwise ON
		exhaust temp.< Th06 Thermostat	Retry Ignition from the Variable Phase; in case of ignition attempts are over, it goes in Extinguishing with alarm Er12			
		at the end of T06 timer: if exhaust temp.> (Th06+D01)	→ goes in Run Mode			
	P71=3 or P74,P75,P76=18	Light flame < L01 Thermostat for at least 60 seconds	Retry Ignition from the Variable Phase; in case of ignition attempts are over, it goes in Extinguishing with alarm Er12			OFF
At the end of T06 if light flame > L01 Thermostat		→ goes in Run Mode				

6.1.5 IGNITION RECOVERY

Wait

Timer		Control Thermostats		Combustion		Heating Resistance
				Fan	Auger	
T13	P71≠3 and P74,P75,P76≠18	exhaust temp.> Th01 Thermostat	→ starts T13	P23	OFF	OFF
		At the end of T13 exhaust temp.>Thermostat Th01	→ waits			
		Light flame > L00 Thermostat	→ starts T13			
		Light flame > L01 Thermostat	→ goes in Ignition			

Brazier Cleaning

Timer		Control Thermostats		Combustion		Heating Resistance
				Fan	Auger	
-		This phase is realized only if an output is set as Brazier Cleaning Engine; it ends when the engine stops		OFF (Maximum Speed if A67=1)	OFF	OFF

Final Cleaning

Timer		Control Thermostats		Combustion		Heating Resistance
				Fan	Auger	
T16	P71≠3 and P74,P75,P76≠18	If exhaust temp.< Th01 Thermostat and T13 timer finished	→ starts T16 timer	Max speed	OFF	OFF
		At the end of T16 if exhaust temp.<Thermostat Th01	→ goes in Check Up			
	P71=3 or P74,P75,P76=18	If Light flame < L00 Thermostat	→ starts T16 timer			
		At the end of T16 if light flame < L00 Thermostat	→ goes in Check Up			

Auger On

Timer		Control Thermostats		Combustion		Heating Resistance
				Fan	Auger	
T50	P71≠3 and P74,P75,P76≠18	If exhaust temp.< Th01 Thermostat	→ starts the timer T50	OFF	Always ON	OFF
		P71=3 or P74,P75,P76=18				

NOTE: The system can go in Ignition Recovery, in Combi 2 modality, also if it is turned on again, once it was turned off in Wood mode, and if the Cleaning Brazier Engine is present.

6.1.6 RUN MODE

Timer		Control Thermostats		Combustion		Heating Resistance
				Fan	Auger	
T14	P71≠3 and P74,P75,P76≠18	When combustion has reached final power, if: exhaust temp.< Th03 thermostat or exhaust temp.< Extinguishing Thermostat for the used power	→ starts T14 timer	User Power	User Power	OFF
		at the end of T14 timer if exhaust temp. is low	→ goes in Extinguishing with alarm Er03			
	P71=3 or P74,P75,P76=18	Light flame < Thermostat L00	→ starts T14			
		at the end of T14 timer if light flame < Thermostat L00	→ goes in Extinguishing with alarm Er03			
System with Thermocouple	Exhaust temp > Th08 thermostat	→ goes in Safety				
	Water temp.> Th25 thermostat					

	System with Thermocouple	Exhaust temp. > Th07 thermostat				
		Water temp.> Boiler Thermostat or A32=1 and the system is a time off of internal chrono or Room temp.> Room Thermostat and A01=1* or Room temp.> Remote Room Thermostat and A52=1 *	→ goes in Modulation			
T22		Room temp.> Room Thermostat and A01=2, 4, 5, 7* or A32=2,4 and the system in a time off of internal chrono or P26=4, 8, 10 and buffer temp.> Buffer Thermostat** or P26=2, 3, 11 and Summer mode and buffer temp.> DHW Thermostat or P26= 11 and Winter Mode and buffer temperature> Buffer Thermostat** and DHW buffer temperature> DHW Thermostat or P26= 0, 1 and A45=1 and there is not DHW demand and Summer mode or room temp.> Remote Room Thermostat and A52=2,4,5,7 *	→ goes in Standby at the end of T22 timer			

* This condition is true if there isn't a sanitary water demand, or if is set a plumbing plant with buffer

** If the Bottom Buffer Probe is present, the buffer charge ends when both the Buffer Thermostats, **Th58** and **Th85**, are satisfied. Charging resumes if buffer temperature < (Buffer Thermostat **Th58** - **Ih58**-1)

6.1.7 MODULATION

Timer		Control Thermostats		Combustion		Heating Resistance
				Fan	Auger	
T14	P71≠3 and P74,P75,P76≠18	Se When combustion has reached final power, if: exhaust temp.< Th03 thermostat or exhaust temp.< Extinguishing Thermostat for the used power	→ T14 timer of pre-extinguishing starts	U11	C11	OFF
		at the end of T14 timer if exhaust temp. is low	→ goes in Extinguishing with alarm Er03			
	P71=3 or P74,P75,P76=18	Light flame < Thermostat L00	→ starts T14			
		at the end of T14 timer if light flame < Thermostat L00	→ goes in Extinguishing with alarm Er03			
	System with Thermocouple	Exhaust temp. > Th08 thermostat	→ goes in Safety			
		water temp.> Th25 thermostat				

T22	<p>Room temp.>Room Thermostat and A01=2, 4, 5, 7 * or A32=2,4 and the system in a time off of internal chrono or water temp.>(Boiler Thermostat+D23) and A13=1 and T43=0 or A13=2, Summer modality and T43=0 or P26=4, 8, 10 and buffer temperature> Buffer Thermostat ** or P26=2, 3, 11 and Summer Mode DHW Buffer temperature > DHW Thermostat or P26=11 and Winter Mode and buffer temperature>Buffer Thermostat **and DHW buffer temperature> DHW Thermostat or P26=0, 1 and A45=1 and there is not DHW demand and Summer Mode or Room temperature> Remote Toom Thermostat and A52=2, 4, 5, 7 *</p>	→ goes in Standby at the end of T22 timer			
<p>When the conditions for Modulation are over, the system goes back to Run Mode * This condition is true if there isn't a sanitary water demand or if a plumbing plant with buffer is set ** If the Bottom Buffer Probe is present, the buffer charge ends when both the Buffer Thermostats, Th58 and Th85, are satisfied. Charging resumes if buffer temperature < (Buffer Thermostat Th58 - Ih58-1)</p>					

6.1.8 STANDBY

In all phases if the flue gas temperature>**Th08** Thermostat or water temperature>**Th25** Thermostat the system is in Safety.

If the Bottom Buffer Probe is present, and the system is in Standby for Buffer Thermostat **Th58** and **Th85**, the system exits the state if buffer temperature < (Buffer Thermostat **Th58** - **Ih58-1**).

To reduce oscillations between states Standby→Ignition→Run Mode→Standby, adjust Room Thermostat Hysteresis and Boiler Thermostat Hysteresis. Anyway Standby lasts at least 10 seconds. Setting the **A27** parameter it is to get the brazier in Maintenance or in Extinguishing.

- **Standby-Extinguishing (A27=0)**

When the conditions that led to the system in Standby aren't valid, the **T11** timer starts (if **A26=1** from Wait phase, if **A26=0** from any phase). At the end the system goes in Check-Up.

Extinguishing

Timer		Control Thermostats		Combustion		Heating Resistance
				Fan	Auger	
T57	P71≠3	exhaust temp > Thermostat Th28	→ starts T57 timer	U12	OFF	OFF
		At the end of timer T57 if exhaust temp.> Th28 thermostat	→ wait			
	P71=3	Light flame > Thermostat L00	→ starts T57 timer			
		At the end of T57 if light flame > Thermostat L00	→ wait			

Brazier Cleaning

Timer		Control Thermostats	Combustion		Heating Resistance
			Fan	Auger	
-		This phase is realized only if an output is set as Brazier Cleaning Engine; it ends when the engine stops.	OFF (Maximum Speed if A67=1)	OFF	OFF

Final Cleaning

Timer		Control Thermostats	Combustion		Heating Resistance	
			Fan	Auger		
T58	P71≠3 and P74,P75,P76≠18	At the end of timer T57 if exhaust temp.< Th28 thermostat	Max speed	OFF	OFF	
	P71=3 or P74,P75,P76=18	At the end of T57 timer if light flame < Thermostat L00				→ starts T58 timer
		At the end of T58 timer				→ wait

Auger On

Timer		Control Termostatos	Combustión		Resistencia Encendido
			Ventilador	Sinfin	
T50	P71≠3 and P74,P75,P76≠18	If exhaust temp.< Th01 Thermostat	OFF	Always ON	OFF
	P71=3 or P74,P75,P76=18	If Light flame < L00 Thermostat			

Wait

Timer		Control Thermostats	Combustion		Heating Resistance
			Fan	Auger	
-		-	OFF	OFF	OFF

- **Standby-Maintenance (A27=1)**

When the conditions that led to the system in Standby aren't valid, the **T11** timer starts. At the end the system goes in Check-Up

Pause

Timer		Control Thermostats	Combustion		Heating Resistance
			Fan	Auger	
T32		Extinguishing of the combustion for the T32 time. At the end start the Work phase	OFF	OFF	OFF

Work

Timer		Control Thermostats	Combustion		Heating Resistance
			Fan	Auger	
T33		Combustion on for the T33 time. At the end start the Pause phase	U12	C12	OFF

6.1.9 SAFETY

Timer		Control Thermostats		Combustion		Heating Resistance
				Fan	Auger	
T15	System with Thermocouple	exhaust temp. > Th08 thermostat	→ starts T15 timer	Power used in the previous state	OFF	OFF
		exhaust temp. < Th08 thermostat	→ goes to the previous state (Modulation or Standby)			
		water temp. > Th25 thermostat	→ starts T15 timer			
		water temp. < Th25 thermostat	→ goes to the previous state (Modulation or Standby)			
		at the end of T15 timer	→ goes in Extinguishing with Error			

6.1.10 EXTINGUISHING

During all the Extinguishing phase, in case of Combi 2, if the system was turned off in Pellet Mode and Exhaust Temperature > **Th68**, the system passes to Wood Extinguishing.

Wait

Timer		Control Thermostats		Combustion		Heating Resistance
				Fan	Auger	
T13	P71≠3 and P74,P75,P76≠18	exhaust temp. > Th01 thermostat	→ starts T13 timer	P23	OFF	OFF
		At the end of T13 timer if exhaust temp. > Thermostat Th01	→ wait			
	P71=3 or P74,P75,P76=18		→ starts T13 timer			
		At the end of T13 timer if light flame > Thermostat L00	→ wait			

Brazier Cleaning

Timer		Control Thermostats		Combustion		Heating Resistance
				Fan	Auger	
-		This phase is realized only if an output is set as Brazier Cleaning Engine; it ends when the engine stops.		OFF (Maximum Speed if A67=1)	OFF	OFF

Final Cleaning

Timer		Control Thermostats		Combustion		Heating Resistance
				Fan	Auger	
T16	P71≠3 and P74,P75,P76≠18	exhaust temp.< Th01 thermostat and T13 finished	→ starts T16 timer	Max speed	OFF	OFF
	P71=3 or P74,P75,P76=18	Light flame < Thermostat L00				
Control at the end of T16 timer: the system goes in Off if there isn't any functioning error, otherwise it goes in Block.						

Auger On

Timer		Control Thermostats		Combustion		Heating Resistance
				Fan	Auger	
T50	P71≠3 and P74,P75,P76≠18	exhaust temp.< Th01 thermostat	→ starts T50 timer	OFF	Always ON	OFF
	P71=3 or P74,P75,P76=18	Light flame < Thermostat L00				

6.1.1.1 BLOCK

Timer		Control Thermostats		Combustion		Heating Resistance
				Fan	Auger	
	P71≠3 and P74,P75,P76≠18	exhaust temp.> Th01 thermosta		U03	OFF	OFF
		exhaust temp.< Th01 thermosta		OFF		
	P71=3 or P74,P75,P76=18	Light flame > Thermostat L00		U03		
		Light flame < Thermostat L00		OFF		

6.2 WOOD MODALITY

6.2.1 BLOCK AND OFF WOOD

Phase	Timer	Control Thermostats		Combustion		Heating Resistance
				Fan	Auger	
				OFF	OFF	OFF

6.2.2 WOOD RUN MODE

If the exhaust temperature is lower than **Th13** thermostat, starts the **T21** timer: if the temperature rises above this thermostat, the timer is reset, otherwise the system returns to Off state.

Phase	Timer	Control Thermostats	Combustion		Heating Resistance
			Fan	Auger	
		exhaust temp.> Th07 Thermostat or water temp.> Boiler Thermostat or room temp.> Room Thermostat and A01 =1,5, 6, 7 * or room temp.> Remote Room Thermostat and A52 =1, 5, 6, 7 *			
		Room temperature> Room Thermostat and A01 =2, 4 or P26 =4, 8, 10 and A49 =1 and buffer temperature> Buffer Thermostat ** or P26 =2, 3, 11 and Summer Mode and DHW buffer temperature> DHW Thermostat or P26 =11 and Winter Mode and buffer temperature> Buffer Thermostat ** and A49 =1 and DHW buffer temperature> DHW Thermostat or Room temperature> Remote Room Thermostat and A52 =2, 4	→ goes in Modulation	User Power If A36 =1, otherwise OFF	OFF
		exhaust temp.> Th08 thermostat or water temp.> Th25 thermostat	→ goes in Standby at the end of T22 timer		
			→ goes in Safety		

* This condition is true if there isn't a sanitary water demand
** If the Bottom Buffer Probe is present, the buffer charge ends when both the Buffer Thermostats, **Th58** and **Th85**, are satisfied. Charging resumes if buffer temperature < (Buffer Thermostat **Th58** - **Ih58**-1)

6.2.3 WOOD MODULATION

Phase	Timer	Control Thermostats	Combustion		Heating Resistance
			Fan	Auger	
		exhaust temp.> Th08 thermostat or water temp.> Th25 thermostat	→ goes in Safety		
		Exhaust temp< Th07 thermostat and Water temp< Boiler Temperature and Room temp< Room Thermostat and A01 = 1, 5, 6, 7 and Room temp< Remote Room Thermostat and A52 = 1, 5, 6, 7	→ goes in Run Mode	OFF if it was off in Run Mode, otherwise U11	OFF
		Room Temp> Room Thermostat and A01 =2,4 or Water Temp> (Boiler Thermostat + D23) and A13 =1 and T43 =0 or A13 =2, Summer Mode and T43 =0 or P26 =4, 8, 10 and A49 =1 and buffer temperature> Buffer Thermostat ** or P26 =2, 3, 11 and Summer Mode and DHW buffer temperature > DHW Thermostat or P26 =11 and Winter Mode and buffer temperature> Buffer Thermostat ** and A49 =1 and DHW buffer temperature> DHW Thermostat or Room temperature> Remote Room Thermostat and A52 =2, 4	→ goes in Standby at the end of the timer T22		

** If the Bottom Buffer Probe is present, the buffer charge ends when both the Buffer Thermostats, **Th58** and **Th85**, are satisfied. Charging resumes if buffer temperature < (Buffer Thermostat **Th58** - **Ih58**-1)

6.2.4 WOOD STANDBY

In all phases if the flue gas temperature > **Th08** Thermostat or water temperature > **Th25** Thermostat the system is in Safety.

If the Bottom Buffer Probe is present, and the system is in Standby for Buffer Thermostat **Th58** and **Th85**, the system exits the state if buffer temperature < (Buffer Thermostat **Th58** - **Ih58**-1).

To reduce oscillations between states Standby→Ignition→Run Mode→Standby, adjust Room Thermostat Hysteresis and Boiler Thermostat Hysteresis. Anyway Standby lasts at least 10 seconds. Setting the **A27** parameter it is to get the brazier in Maintenance or in Extinguishing.

Phase	Timer	Control Thermostats		Combustion		Heating Resistance
				Combustion	Auger	
<ul style="list-style-type: none"> Extinguishing (A27=0) 						
<i>Extinguishing</i>		Exhaust temp < Th13 thermostat	→ Extinguishing of the combustion	U12 if A36 =1, otherwise OFF	OFF	OFF
<i>Auger On</i>	T50	Exhaust temp < Th13 thermostat	→ T50 timer starts	OFF	Always ON	
<i>Wait</i>			→ wait	OFF	OFF	
<ul style="list-style-type: none"> Maintenance (A27=1) 						
<i>Pause</i>	T32	Extinguishing of the combustion for the T32 time. At the end starts the Work phase		OFF	OFF	OFF
<i>Work</i>	T33	Combustion on for the T33 time. At the end starts the Pause phase		U12 if A36 =1, otherwise OFF		
When the conditions that led to the system in Standby are no longer valid, the T11 timer starts. At the end, the system goes in Run Mode .						
In all phases if the flue gas temperature > Th08 Thermostat or water temperature > Th25 Thermostat the system goes in Safety.						
To reduce oscillations between states Standby→Ignition→Run Mode→Standby, adjust Room Thermostat Hysteresis and Boiler Thermostat Hysteresis. Anyway, Standby lasts at least 10 seconds.						

6.2.5 WOOD SAFETY

Phase	Timer	Control Thermostats		Combustion		Heating Resistance
				Fan	Auger	
		exhaust temp. > Th08 thermostat or water temp. > Th25 thermostat	→ Wait	OFF	OFF	OFF
		exhaust temp. < Th08 thermostat and water temp. < Th25 thermostat	→ goes in the state in which it was before (Standby or Modulation)			

6.2.6 WOOD EXTINGUISHING

Phase	Timer	Control Thermostats		Combustion		Heating Resistance
				Fan	Auger	
<i>Wait</i>		exhaust temp. > Th13 thermostat	→ Wait	U12 if A36 =1, otherwise OFF	OFF	OFF

<i>Auger On</i>	T50	exhaust temp.< Th13 thermostat	→ start T50 timer	OFF	Always ON
		exhaust temp.< Th13 thermostat	→ goes in Off	OFF	OFF

6.3 COMBI MODALITY

By parameter **P11** you can configure user-selectable modes of operation for the current system:

Only Pellet Mode (P11=0)

In this configuration the system can only operate at Pellet Mode and in the User Menu, the submenu functioning isn't present.

Only Wood Mode (P11=1)

In this configuration the system can only operate at Wood Mode and in the User menu, the submenu functioning isn't present.

Wood/Pellet Mode (P11=2)

In this configuration the system can operate both Pellet and Wood Mode, but not at the same time. Through the *submenu functioning* of the User Menu you can select the desired operation.

Combi Mode 1 (P11=3)

In this configuration, the system can operate in Pellet, Wood and also in combination.

Through the *submenu functioning* of the User Menu you can select the Pellet, Wood or Combi Mode (on display appears the symbol .

The combi mode 1 allows to turn on again automatically in pellet mode, when the wood in the brazier is finish. When the system is in Pellet mode, the combi mode is deactivated.

When the system is turned on, it starts in Wood Mode. If the exhaust temperature measured by the thermostat is higher than the **Th13** is loaded timer **T21**; if later the temperature is lower than **Th13** for **T21** minutes the system turn on again automatically in Pellet Mode.

For safety reason, the transition from wood to pellets is not allowed until the water temperature in the boiler is higher than the Boiler Thermostat.

Combi Mode 2 (P11=4)

In this configuration, the system can operate in Pellet, Wood and also in combination.

Through the submenu *Functioning* of the User Menu you can select the Pellet, Wood or Combi Mode (on display appears the symbol .

The Combi mode 2 turns on the system in Pellet mode and allows to burn the wood, and finally enter in Wood Mode. When the wood is over the system goes in Pellet mode. This modality doesn't turn off automatically, to perform the **Combi** cycle again you must first turn the system off and then on again.

In mode 2 Combined the ignition of wood with pellets is carried out considering the parameter **P71**. If:

- **P71**≠3 and **P74,P75,P76**≠18 are considered thermostats **Th63, Th66, Th69** instead of thermostats **Th03, Th06, Th09**
- **P71**=3 or **P74,P75,P76**=18 is considered thermostat **L01**

If the system passes the phases of Ignition and Stabilization, comes up to speed and starts the timer **T71**. During the time **T71** the system can only go in Safety or Modulation / Standby for Boiler Temperature according to the parameter **A13**.

At the exit from Standby, the system resumes from Ignition phase, restarting the Ignition of Wood with pellets.

Depending on the value of the **PA23** parameter, the system will work in the following way:

- **PA23=0**

During **T71** timer, if the exhaust temperature is higher than **Th64** thermostat, the system goes in Wood Mode otherwise, at the end of the timer, continues to work with Pellet.
When the wood is finished (exhaust temp < **Th13** thermostat) at the end of the **T21** timer, the system turns on again in pellet mode automatically (the thermostats considered are **Th03, Th06, Th09**).
If during Pellet Mode after the end of the wood, the exhaust temperature becomes greater than **Th68** thermostat, the system goes again in Wood Mode and the Combi cycle restarts.
Transition from Wood to Pellet is not allowed if **Door** input is Open.
- **PA23=1**

As follows two different operations depending on the value of the **PA29** parameter

 - **PA29=0**

In this case, the Door input is used for the system transition to Wood.
Once the system came up to speed, at the end of **T71** timer, the thermostat **Th64** is checked: if exhaust temperature is greater than it the system passes to Wood mode, otherwise it keeps working with Pellet. Here the system keeps checking the **Th68** thermostat for the transition to Wood.

If the system successfully passed to Wood, once it finished (exhaust temperature lower than the thermostat **Th13**) when the timer **T21** expires, the system turns on again with Pellet automatically (thermostats **Th03, Th06, Th09**).

The system keeps working with Pellet until the Door is open, and consequently closed. This condition starts the timer **T71** and, from its expiring, the thermostat **Th68** is checked. If exhaust temperature is greater than it the system passes to Wood, otherwise it will keep working with Pellet.

For the **Th68** thermostat control, the opening / closing of the door can take place both in Wood or Pellets phase.

○ **PA29≠0**

In this case, the functioning is managed only with door present. During ignition, once fully operational, the system is brought to work to the fixed power **PA29**. At the end of the timer **T71, Th64** thermostat is checked: if Exhaust temperature is greater than it, the system passes to Wood, otherwise it will keep working with Pellet, power is not fixed to **PA29** and no more controls for transition are carried out, unless the door is open (and then closed). In that case, the system fixes again the power to **PA29**, starts counting **T71** and, when this timer expires, checks the thermostat **Th68**: if Exhaust temperature is greater than it, the system switches to Wood mode. When **T71** timer expires, working power is no more fixed, while **Th68** thermostat is still monitored.

If the system successfully passed to Wood, once it finished (exhaust temperature lower than the thermostat **Th13**) when the timer **T21** expires, the system turns on again with Pellet automatically (thermostats **Th03, Th06, Th09**).

Now the system keeps working in Pellet mode (with not fixed power) until the Door is open, and consequently closed. That condition lead the system to fix the power at PA29 and makes the timer **T71** start. When it expires, the **Th68** thermostat is monitored: if exhaust temperature is greater than it, the system switches to Wood, otherwise it will keep working with Pellet. When T71 expires, working power is no more fixed, while **Th68** thermostat is still monitored.

For the **Th68** thermostat control, the opening / closing of the door can take place both in Wood or Pellets phase.

7 OTHER FUNCTIONS

7.1 INTERNAL CHRONO MANAGEMENT

The control board is provided with a clock module for the management of programmed switching on and off (this feature is available only in **Pellet modality**). Setting the parameter **A32** it is possible to:

- **A32=0**→the chrono manages the system's Ignition/Extinguishing.
This functioning is only available in pellet mode or in Combination mode and parameter P11 = 4 (Combi 2).
- **A32=1**→the chrono sends the system in Modulation outside the programmed time on bracket.
- **A32=2**→the chrono sends the system in Standby outside the programmed time on bracket.
- **A32=3**→the chrono blocks the plant pump outside the programmed time on bracket if the water temperature in the boiler exceeds the **Th19** thermostat. If the temperature exceeds the **Th21** thermostat the pump turn on.
- **A32=4**→the chrono works as in the cases 2 and 3

NOTE:

- If there is a sanitary water demand the pump system isn't blocked and, if it previously had been blocked, it is reactivated.
- If the parameter **A13=2**, on Summer all functioning of the Room Thermostat are disabled except the one with **A01=0**.

7.2 COMBUSTION STANDBY

The Standby is a temporary shutdown of the flame due to the attainment of the target temperature of the medium to be heated. The conditions to go in Standby are managed by parameters **A01**, **A52** and **A13**:

- **A01**, **A52=2, 4, 5, 7**→if room temperature>Room Thermostat, the system goes in Standby
- **A13=0**→if boiler water temperature>Thermostat Boiler, the system goes in Modulation
- **A13=1**→if boiler water temperature>(Boiler Thermostat+**D23**)→when the timer **T43** is finished, the system goes in Standby
- **A13=2**→ On Winter if water temperature > Boiler Thermostat →the system goes in **Modulation**
On Summer if water temperature > (Boiler Thermostat + **D23**) → the system goes in Standby at the end of **T43** Timer.

To exit Standby set the values of the thermostats' hysteresis. The system exits from standby if:

Room temperature<(Room Thermostat-**Ih33-1**) **and**
Room remote temperature<(Room Remote Thermostat-hysteresis-1) **and**
water boiler temperature<(boiler thermostat-**Ih24-1**)

7.3 AUTOMATIC COMBUSTION POWER

In the Combustion Power Menu, the user can set the Automatic modality [A]. The work power is automatically selected according to the water boiler temperature and the value of Boiler Thermostat **Th24**:

- boiler water temperature≤**Th24-d08**→the system goes to the maximum available power
- **Th24-d08**<boiler water temperature<**Th24**→the combustion power decreases reaching the Boiler Thermostat
- boiler water temperature≥**Th24**→the system goes to Power 1 if **A06=0** or to Modulation Power if **A06=1**

Example: **Th24=75** °C, **d08=5** °C, **P03=5**, Modality=Automatic

Water Temperature (°C)	≤ 70	71	72	73	74	≥ 75
Combustion Power	5	4	3	2	1	1 or Mod.

7.4 CHANGE POWER DELAY

When the system exits from the Ignition and goes in Run Mode, the Combustion Power, starting from the Power 1, reaches the target one increasing the value with the delay time as the timer **T18**.

The other manual or automatic power changes are managed and actuated with the delay time as timer **T17**.

7.5 SYSTEM MAINTENANCE 1 FUNCTION

When the system exceeds the working hours set by the parameter **T66** it is notify the user to contact the service to verify the proper functioning of the system. The display shows the message 'Service' and the system, if **P86=1** goes in Block. To unblock the system, or if **P86=0** to disappear the message 'Service', it is necessary to reset the counter in the menu 'Reset Service'. To disable this feature set **T66=0**, to enable it set **T66>0**.

7.6 SYSTEM MAINTENANCE 2 FUNCTION

When the system exceeds the working hours set by the parameter **T67** it is notified to the user to clean the boiler or the stove. The display shows the message 'Clean' and the system gives out an acoustic signal periodically. To stop signalling enter the menu 'Cleaning Reset'. To disable this feature set **T67**=0.

7.7 FAST EXTINGUISHING

This function allows to get the system in Off state jumping the Extinguishing phase. To enable it follow the procedure:

1. put the system in the Extinguishing state without errors
2. turn off the system
3. turn on the system pressing the On/Off button for 3 seconds

The errors' check is guaranteed.

7.8 EXTINGUISHING IN IGNITION PHASE

When the system is turned off during the Ignition phase (after Preheating phase) by an external device or by internal chrono, it really goes in Extinguishing when it enters the Run Mode at the end of Ignition. On display appears the message "Block Ignition".

In Combi 2 modality if the system is turned off (also with manual control):

- **PA23**=0 the System does the extinguishing if exhaust temp. > **Th64** or if **T71** is expired. In the first case the extinguishing is performed in Wood modality, in the second case in Pellet modality. Furthermore in this case, if exhaust temp. > **Th68** the extinguishing switches to Wood modality.
- **PA23**=1. The System, when **T71** expires, checks exhaust temperature. If it's greater than **Th64** extinguishing is performed in Wood mode, otherwise in Pellet mode. , the system goes on with the extinguishing in pellet modality. If exhaust temperature is > **Th64** the system starts a checking procedure, similar to that of Wood transition described in section 6.3. In this case, the system can switch to Wood extinguishing. Furthermore in this case, if exhaust temp. > **Th68** the extinguishing switches to Wood modality

If it occurs any error, the system goes immediately in Extinguishing with error.

If the On/Off button is pressed it is possible to get immediately the system in Extinguishing or in Ignition.

7.9 AUTOMATIC SWITCH OFF FUNCTION

If the parameter **A40** is greater than 0 and the functioning is in Pellet modality the system, after **T84** minutes in Run Mode, Modulation and Standby-Maintenance goes in Ignition Recover.

If **A40**=2 the length of extinguishing phase of Ignition Recover is **TM18** seconds and the thermostats aren't used.

7.10 SUPPLY VOLTAGE LACK MANAGEMENT

In case of supply voltage lack, the system saves the most important functioning data. With the return of the supply voltage, the system evaluates the saved data and, according to parameter **A53** we have:

- **A53**=0
 - If the lack is less than **T88** the system returns to the state in which it was previously
 - If the system was in a On state and the lack of voltage is between **T88** and **T89** the system goes in Recover Ignition, if it is in Pellet modality; it goes in Run Mode if in Wood modality
 - In case of lack of Supply Voltage for a time greater than **T89** the system goes in Block with error message **Er15**
- **A53**=1
 - If the lack is less than **T88** the system returns to the state in which it was previously
 - If the system was in a On state and the lack of voltage is greater than **T88** the system goes in Recover Ignition, if it is in Pellet modality; it goes in Run Mode if in Wood modality

7.11 AUGER FEEDING IN WOOD MODALITY

When the system is in Wood modality and in the states Run Mode and Modulation is possible to feed the Auger and download pellets in the brazier.

If the flue gas temperature is greater than **Th13** thermostat, the Auger is off for the time **T53** and it is on for the time **T54**; if a configurable output is set as the Safety Valve (**P44** or **P48** or **P36**=1) the Auger is turned on only at the end of time **T40**.

If the Combustion Fan was off, it is turned on at the speed **U12**, otherwise it continues to work on the power to which it was working. If the fuel in the tank is run out, the function is disabled.

7.12 PERIODICAL CLEANING OF BRAZIER

Periodical Cleaning of brazier occurs in Run Mode for a time **T08** with a repetition time equal to **T07** timer. During the cleaning phase the, Exhaust Fan goes to at **U09** power and the Auger at **C09**.

7.13 CONFIGURABLE OUTPUTS MANAGEMENT

It is possible to configure the outputs V2 (pins 5-6), Aux2 (pins 19-20-21) and Aux3 (pins 46-47) setting the parameter **P44**, **P48** and **P36**.

7.13.1 SAFETY VALVE

The output is on when the Auger is enabled to work; the Auger will be on only at the end of timer **T40**. Preheating phase of the Ignition phase, the work phase of Standby-Maintenance and the Auger feeding in Wood modality will only start if the timer **T40** expires.

<i>State System</i>	<i>Safety Valve</i>
Check Up, Ignition, Stabilisation, Run Mode, Modulation, Standby-Maintenance (work phase), Safety, Extinguishing (Advancement Auger phase)	On
Other States	Off

7.13.2 LOAD PELLET ENGINE

When the Pellet Level Sensor signals the absence of pellet, the output is activated to do the loading of the tank. If in a time **T24** is not reached the set pellet level, the system goes in Extinguishing and the display shows the message **Er18**. If the tank is filled manually, it is possible to reset the error and restart the system. If the set pellet level is reached, the loading of the material continues for a time equal to **T23**.

7.13.3 OUTPUT UNDER THERMOSTAT

The output is managed by **Th56** Thermostat: above this value is supplied.

7.13.4 CLEANING ENGINE

The Cleaning Engine 1 is allowed to work:

- in Extinguishing, Recover Ignition, Standby-Extinguishing (**A27**=0) prima before the Final Cleaning phase. The cleaning is repeated **PA62** times. To disable the cleaning in these phases set **PA62**=0.
- in Check Up before the Cleaning phase. The cleaning is repeated **PA63** times. To disable the cleaning in this phase set **PA63**=0.
- in Run Mode and Modulation when the working time exceeds the value of the parameter **T31**, the cleaning starts while the combustion parameters remain the same. The cleaning is repeated **P80** times. To disable the cleaning set **P80**=0. In Wood mode the time **T31** is counted also in Safety and Off if Exhaust flue gas temperature is greater than the thermostat **Th13**. **For safety reasons the motor is always turned-off when the system is in Off and Block**

It is possible to manage the cleaning motor with or without limit switch:

- Management with limit switch (**P73**, **P74**, **P75**, **P76** o **P70** =are set to 10)

<i>Phase</i>	<i>Description</i>
Phase 1	The system activates the motor and verifies the limit switch status: when it opens, it passes to Phase 2. If, upon expiry of the T85 timer, the limit switch is closed, the system goes in Block state with error Er26 .
Phase 2	The maximum duration of this Phase is T30 seconds: during this time the motor must have moved forward or completed its cleaning cycle. At the end of the system moves to Phase 3.
Phase 3	The maximum duration of this phase is T100 seconds: for this time the motor is turned-off and must be repositioned in the starting position (the limit switch must be closed again). At the end the system moves to Phase 4. If, at the end of T100 the limit switch is still open the system goes into Block state with error Er26 .
Phase 4	If the number of set cleaning cycles is greater than one, starts another cycle of cleaning, otherwise the motor is switched off.

If during the normal functioning the controller should read the limit switch as "open", the Cleaning Motor is turned on to try to close the contact; if it does not close, the system goes in Block with error message **Er26**.

- management without limit switch (**P73**, **P74**, **P75**, **P76** o **P70** =are set to 0)

<i>Phase</i>	<i>Description</i>
Phase 1	The system starts the motor for T30 seconds: during this time the motor must complete its forward movement or the entire Cleaning Cycle. At the end the system moves to Phase 2.
Phase 2	This phase lasts T100 seconds: During this time the motor is off and must have repositioned itself in the starting position. At the end the system moves to Phase 3.

Phase 3	If the set number of Cleaning Cycles is greater than one another Cleaning Cycle will start, otherwise the motor will be turned-off.
---------	---

7.13.5 COMBUSTION FAN 2

If the parameter **P44**=5 the output V2 is configured as a Combustion Fan 2. Its power is the same of Combustion Fan 1.

7.13.6 HEATING FAN

If the parameter **P44**=6 the output V2 is configured as a Heating Fan.

It has the following functioning:

- If exhaust temperature is greater than Thermostat **Th07** at the end of **T69**, it goes at maximum power (230V)
- If the user set a power greater than zero:
 - it is on only if the flue gas temperature is greater than the **Th05** Thermostat
 - if the system is Modulation or Standby or if room temperature > Room Thermostat, if **A03**=0 the fan is Off, if **A03**=1 it goes at Power 1

If the user chooses the automatic heating mode is the system to select the power. Setting the parameter **P06** it is possible to manage the automatic mode 3 different ways:

- **P06=1 (same as combustion power)**
In Run Mode the heating power is the same of combustion power, in the other states is power 1.
- **P06=2 (proportional to exhaust temperature)**
The system selects the correct power according to the current value of the flue gas temperature, the value of parameters **D04** and thermostat **Th05**.
Example: Th05=60°C, Delta D04=100 °C, Power's number=5
 - exhaust temperature < **Th05** the fan is Off
 - exhaust temperature > (**Th05+D04**)=160 °C the fan goes to power 5
 - **Th05**<exhaust temperature < (**Th05+D04**) the system increases one functioning power every 25 °C from 60°C

<i>Exhaust Temperature (°C)</i>	< 60	60 ÷ 84	85 ÷ 109	110 ÷ 134	135 ÷ 159	≥160
<i>Power</i>	Off	1	2	3	4	5

- **P06=3 (proportional to room temperature)**
The system selects the heating power according to the heating plant (**P69** parameter), the value of room temperature, the value of Room Thermostat used, and **D05** or **D13** parameter.
If **A19**=0 and the set heating power is automatic, the Heating Power will be the same of Combustion Power.
Example: Room Thermostat=30°C, Delta D05=12°C, Power's number=5
 - room temperature ≤ (**Room Thermostat-D05**)=18 °C the fan goes to power 5
 - room temperature > (**Room Thermostat-D05**) the system decreases one functioning power every 3 °C from 18°C

<i>Room Temperature (°C)</i>	< 18	18 ÷ 20	21 ÷ 23	24 ÷ 26	27 ÷ 29
<i>Power</i>	5	4	3	2	1

7.13.7 AIR VALVE

The output is ON both in Wood and Pellet modality if Combustion Fan is ON, or if the system is in Wood modality and **A36**=0, in Run Mode, Modulation and work phase of Standby-Maintenance.

7.13.8 ERROR SIGNALLING

The output is on if the system is in Block state.

7.13.9 CLEANING ENGINE 2

The Cleaning Engine 1 is allowed to work:

- in Extinguishing, Recover Ignition, Standby-Extinguishing (**A27**=0) before the Final Cleaning phase. The cleaning is repeated **PA64** times. To disable the cleaning in these phases set **PA64**=0.
- in Check Up before the Cleaning phase. The cleaning is repeated **PA65** times. To disable the cleaning in this phase **PA65**=0.
- in Run Mode and Modulation, when the work time exceeds the value of the parameter **T76**, the cleaning starts while the combustion parameters remain the same. The cleaning is repeated for **P79**

times. To disable the cleaning set **P79**=0. In Wood modality **T76** time takes into account also the Safety and Off functioning states if the Exhaust Temperature is higher than **Th13** Thermostat. **For safety reasons the motor is always turned-off when the system is in Off and Block.**

It is possible to manage the cleaning motor with or without limit switch:

- Management with limit switch (**P73, P74, P75, P76** o **P70** =are set to 11)

<i>Phase</i>	<i>Description</i>
Phase 1	The system activates the motor and verifies the limit switch status: when it opens, it passes to Phase 2. If, upon expiry of the T85 timer, the limit switch is closed, the system goes in Block state with error Er27 .
Phase 2	The maximum duration of this Phase is T75 seconds: during this time the motor must have moved forward or completed its cleaning cycle. At the end of the system moves to Phase 3.
Phase 3	The maximum duration of this phase is T101 seconds: for this time the motor is turned-off and must be repositioned in the starting position (the limit switch must be closed again). At the end the system moves to Phase 4. If, at the end of T101 the limit switch is still open the system goes into Block state with error Er27 .
Phase 4	If the number of set cleaning cycles is greater than one, starts another cycle of cleaning, otherwise the motor is switched off.

If during the normal functioning the controller should read the limit switch as "open", the Cleaning Motor is turned on to try to close the contact; if it does not close, the system goes in Block with error message **Er27**.

- management without limit switch (**P73, P74, P75, P76** o **P70** =are set to 0)

<i>Phase</i>	<i>Description</i>
Phase 1	The system starts the motor for T75 seconds: during this time the motor must complete its forward movement or the entire Cleaning Cycle. At the end the system moves to Phase 2.
Phase 2	This phase lasts T101 seconds: During this time the motor is off and must have repositioned itself in the starting position. At the end the system moves to Phase 3.
Phase 3	If the set number of Cleaning Cycles is greater than one another Cleaning Cycle will start, otherwise the motor will be turned-off.

7.13.10 AUGER 2 IN ON-OFF MODE

If the parameter **P44**=16 the V2 output is configured as a second Auger.

Setting **P81**=0, the output is on for an increased time, compared to that of the Auger 1, of a percentage **P72**; the maximum work time is the Auger Period (**P05**). If the parameter **P81**=1, 2 the output is always on if the Auger 1 is on. In Extinguishing and Standby-Extinguishing the output turns off only when the timer **T27** expires.

7.13.11 AUGER 2 ALWAYS ON

The output is on when the Auger is enabled to work and it will be off, compared to the switch off of the first Auger, only at the end of timer **T27**.

<i>State System</i>	<i>Auger 2</i>
Check Up, Ignition, Stabilisation, Run Mode, Modulation, Standby-Maintenance (work phase), Safety	On
Other States	Off

7.13.12 AIR VALVE 3

The output, after a delay of T90 seconds, switches on if the exhaust temperature exceeds the value of the thermostat Th15. If the door opens or any error occurs, the output is switched off.

7.13.13 AIR VALVE 2

The output is ON in Pellet modality if Combustion Fan is on (except in the Ignition state in Preheating, Preload and Fixed phases).

7.13.14 MIXER VALVE

The Mixer Valve is available only if **P26**=7, 8, 9. The management involves the use of two outputs Aux3 and Aux1. The electrical connections and the plumbing plants in which it is enabled are the following:

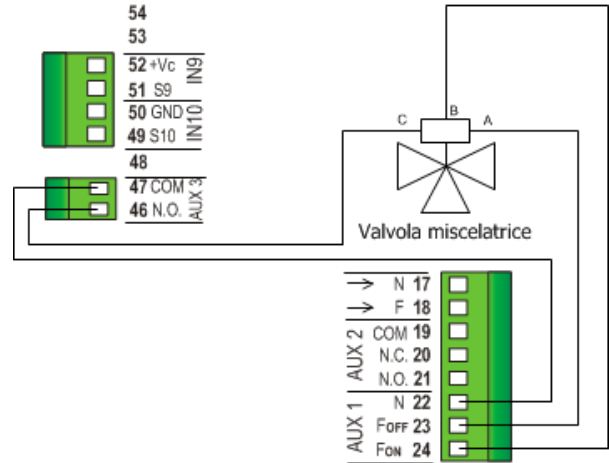
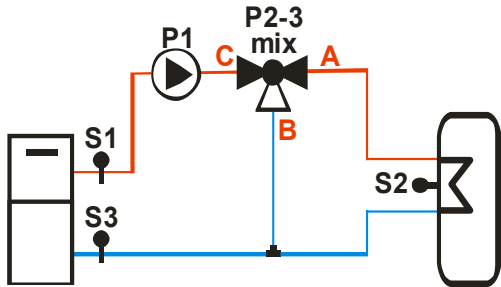
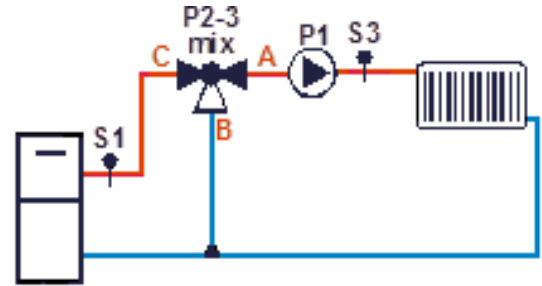
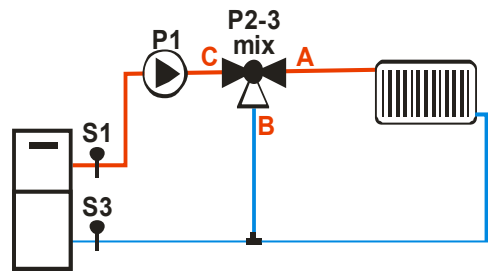

Mixer Valve to adjust the temperature return (P26 = 7 - 8)

For safety reasons if water temperature is greater than **Th21** or **Th25** Thermostat the Valve is opened toward A for twice of **T82** time.

Manual Functioning:

If the user, using the appropriate Menu, can force the Valve opening (toward A) or closure (toward B), the Valve is power supplied for the twice of **T82** time.

Automatic Functioning:

If the user selects the automatic functioning:

- If the Pump is OFF the Valve stays in its current position and the regulation is disabled
- If the Pump is ON and the S3 temperature is less than **Th60** Thermostat – **D40**: the Valve is closed toward B for twice of **T82** time
- If the Pump is ON and the S3 temperature is less than **Th60** thermostat – **Ih60**: the valve is closed toward B for the time **T81** wait for the time **T83** and then check again the S3 temperature
- If the Pump is ON and the S3 temperature is greater than **Th60** Thermostat: The Valve is open toward A for the time **T81** wait for the time **T83** and then check again the S3 temperature
- If the Pump is ON and the S3 temperature is between **Th60** and **Th60-Ih60** The valve remains at the actual state until the temperature doesn't go beyond of one the two thresholds.
- The number of steps available for the adjustment is given by the ratio **T82/T81**
- The adjustment ends after twice the number of steps available, as was certainly achieved complete closure / opening of the valve.

Mixer Valve to adjust the Flow temperature (P26 = 9)

For safety reasons if water temperature is greater than **Th21** or **Th25** Thermostat the Valve is opened toward A for twice of **T82** time.

Functioning with Climatic Function disabled:

If the user, using the appropriate Menu, can set the Flow thermostat **Th70**.

- If the Pump is OFF the valve stays in its current position and the regulation is disabled.
- If the Pump is ON and the S3 temperature is less than **Th70** Thermostat – **D40**: the Valve is closed toward A for twice of **T82** time
- If the Pump is ON and the S3 temperature is less than **Th70** thermostat – **Ih70**: the valve is open toward A for the time **T81** wait for the time **T83** and then check again the S3 temperature
- If the Pump is ON and the S3 temperature is greater than **Th70** Thermostat: The Valve is closed toward B for the time **T81** wait for the time **T83** and then check again the S3 temperature
- If the Pump is ON and the S3 temperature is between **Th70** and **Th70-Ih70** The valve remains at the actual state until the temperature doesn't go beyond of one the two thresholds.
- The number of steps available for the adjustment is given by the ratio **T82/T81**
- The adjustment ends after twice the number of steps available, as was certainly achieved complete closure / opening of the valve.

Functioning with Climatic Function enabled:

The thermostat **Th70** flow is no longer editable by the user, because it is automatically calculated by the system. The rest of the operation is equal to that described with climatic function disabled.

7.13.15 PUMP P3

This kind of output is selected only if the plumbing plant's configuration chosen is the 10 or 11 (parameter **P26**=10 or 11); for more details see section 7.16.

7.13.16 BRAZIER CLEANING ENGINE

The Brazier Cleaning Engine is enabled to work only if the system is in Pellet modality and is activated:

- During the time **T89** in Extinguishing, Recover Ignition, Standby-Extinguishing (**A27**=0) before the Final Cleaning. Fans and augers are off; the cleaning is repeated **P50** times. To disable the cleaning in these phases, set **P50**=0.
- During Check up, before cleaning phase, Fans and Augers are deactivated; the cleaning is repeated **P51** times. To disable the cleaning in this phase set **P51**=0
- Periodically, during the time **TM41**÷**TM48**, when the operating time in Run Mode, Modulation and Standby-Maintenance (**A27**=1) is greater than **T87** parameter. The combustion parameters don't

change; the cleaning is repeated **P49** times. To disable the cleaning, when the system has reached the final power, set **P49**=0.

The Brazier Cleaning Engine management can be done with one output or two.

Management with one output

Set **P44**, **P48** o **P36** at 25.

The Brazier Cleaning Engine management in this case can be done using a limit switch or no:

- management with limit switch (set **P74**, **P75**, **P76**, **P70** or **P73** equal to 12)

Phase	Description
Phase 1	The system activates the motor and checks the state of the limit switch: when it opens it goes to Phase 2. If, when the T85 timer expires, the limit switch is still closed the system goes in Block state with error Er25 .
Phase 2	The maximum duration of this phase is T86 or TM41÷TM48 seconds: during this time the motor must have moved forward or completed its cleaning cycle. At the end, the system moves to Phase 3.
Phase 3	The maximum duration of this phase is T99 seconds: for this time the motor is turned-off and repositioned in the starting position (the limit switch must be closed again). At the end the system moves to Phase 4. If, at the end of T99 the limit switch is still open the system goes into Block state with error Er25 .
Phase 4	If the number of cleaning cycles done is lower than the value set, the system starts a new cleaning cycle otherwise the cleaning function is considered done.

If during the normal operation the control-board reads the limit switch as open, the engine is activated to try to close the contact; if it doesn't do it, the system goes in Block state with the error message **Er25**.

In Off and Block state, for safety concerns, the engine is always still. The system remains in Check Up state until the engine has repositioned.

- management without limit switch

Phase	Description
Phase 1	The system switches on the engine for a time equal to T86 or TM41÷TM48 seconds, in this time, the engine have to complete its forward movement or the entire Cleaning Cycle. At the end, system goes to Phase 2.
Phase 2	This phase lasts T99 seconds: During this time the motor is off and must have repositioned itself in the starting position. At the end the system moves to Phase 3.
Phase 3	If the number of cleaning cycles done is lower than the value set, the system starts a new cleaning cycle otherwise the cleaning function is considered done.

In Off and Block state, for safety concerns, the Engine is always still.

Management with two outputs

Set **P48** at 33; **P44** or **P36** at 25. One output (V2 or Aux3) manages the activation of the engine, Aux2 manages the direction of the engine.

The management of the engine in this case has to be done with the limit switch (set **P74**, **P75**, **P76**, **P70** or **P73** equal to 12).

Phase	Description
Phase 1	The system activates the Engine in FORWARD mode and checks the state of the limit switch: when it opens it goes to Phase 2. If, when the T85 timer expires, the limit switch is still close the system goes in Block sate with error Er25 .
Phase 2	The maximum duration of this phase is T86 or TM41÷TM48 seconds: in this time the Engine is still activated in FORWARD mode. At the end of T86 or TM41÷TM48 (fixed time), the system goes in Phase 3.
Phase 3	The maximum duration of this phase is TM11 seconds: in this time the Engine is activated in BACKWARD mode to return to the normal condition. If, when the TM11 timer expires, the limit switch is still open the system goes in Block sate with error Er25 . If the Limit Switch is closed, the system goes to Phase 4
Phase 4	If the number of cleaning cycles done is lower than the value set, the system starts a new cleaning cycle otherwise the cleaning function is considered done.

At mid and end cycle (before changing direction) the engine is Off for **T103** seconds.

If during the normal operation the thermo-regulator reads the limit switch as open, the Brazier Engine is activated in BACKWARD mode to try to close the contact; if it cannot do it within the **TM11** time, the system goes in Block state with the error message **Er25**.

In Off and Block state, for safety concerns, the Engine is always deactivated (no FORWARD, no BACKWARD).

7.13.17 AUGER BLOCK

The output (which must be a free contact output) is used as a contact protection for the Auger. It has to be connected in series to the Auger and the contact is always closed when the Auger is enabled to work and it is open when it is not, furthermore it is open in case of encoder alarms (Er47 or Er48) when P81=1, 2.

7.14 CLIMATIC FUNCTION

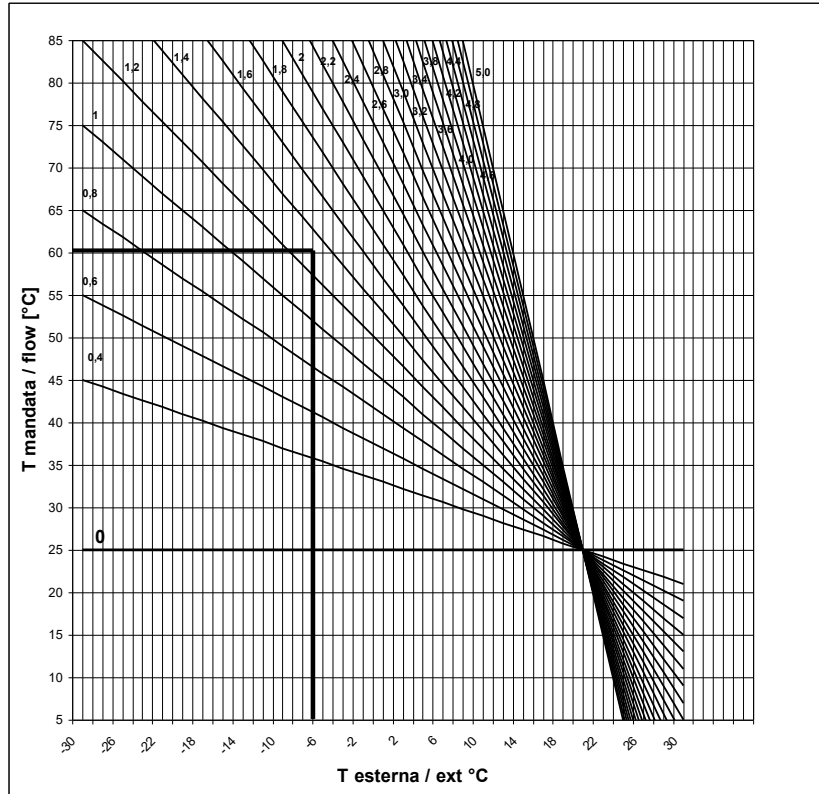

When the function is enable (P74, P75, P76=7 and winter mode) it works as follow:

- Plumbing Plants without Buffer (P26=0, 1, 2, 3, 5, 6, 7)
The Boiler Thermostat is automatically calculated by the system and it varies within the range Th26÷Th27 thermostats. The calculus is based on the read external temperature according to the curves shown in the graph below. The choice of the curves is done by parameter P60 (depending on the latitude of the place of installation of the system).
If there is a sanitary water demand and a plumbing plant with flow switch is selected, the Boiler Thermostat takes the value of Th21-Ih21 (Function Sanitary see section 7.16.2.2), if a plumbing plant without flow switch is selected, Boiler Thermostat takes the value set by the user.
- Plumbing Plants with Buffer (P26= 4, 8)
The Buffer Thermostat is automatically calculated by the system and it varies within the range Th51÷Th52 thermostats. The calculus is done using the same criteria described above.
The Boiler Thermostat is given by the sum of the Buffer Thermostat and D11 delta.
- Plumbing with regulation of Flow (P26=9)
The Flow thermostat is automatically calculated by the system and can change inside of the range Th71÷Th72. This is calculated using the same parameters described above.
The boiler thermostat instead is settable in the User Menu.
- Plumbing 10 or 11 (P26=10, 11)
Function not available

Through the Comfort Function the user can vary by ± 20 °C the thermostat automatically calculated.

7.15 PRIMARY AIR FLOW SENSOR

Setting the parameter P71=1 it is possible to manage the combustion using a primary air flow sensor. Estimating the air flow speed of the inlet it can adjust the scope of the system. **It works in Run Mode and Modulation states in Pellet modality.** For the correct use of the system do the following:

1. Switch on the System with air flow sensor disabled (parameter **A24=0**). In Run Mode and Modulation states monitor the air flow speed for each power of the system.
2. Once found the optimum air flow speed values for each power of the System, start to configure the air flow regulator setting:
 - Set values of the air flow for each power (parameters **FL22÷FL30**).
 - Variation delta of the air flow compared to the set value for each power (parameters **FL52÷FL60**).
 - **T19** the time how often to regulate the combustion (short is this time, less readings will be done by the system).
 - **T20** waiting time with sensor fixed out of the minimum or the maximum range, before to go to regulate another output or before to go in regulation error.
 - **T80** Waiting Time before starts the first regulation.
 - **A24** to set which kind of combustion desired.
 - Regulation Step for each Output (**U60, C60**)
 - Regulation order on the selected output (this function will be active if **A24** is set to regulate two output):
 - If **A31=0** the sensor starts to regulate the first output, goes on the next output if needed, then go back on the first output .
 - If **A31=1** the sensor starts to regulate the first output, goes on the next output if needed and the remain on this output.
 - System functioning in case of failed output regulation:
 - if **A25=0** selected outputs go on working with last values calculated by air flow sensor.
 - if **A25=1** air flow sensor has been Reset and restarts for a new regulation attempt.
 - if **A25=2** air flow sensor is disabled, selected outputs go on working with default settings and the display shows the error **Er17**.
 - if **A25=3** in case of failed regulation, the system goes in Block with alarm **Er17**.
3. At the end of the set-up procedure, it will be possible to restart the System with Air Flow Sensor turned on. The first intervention on the system, to stabilize the combustion, will be after **T80** seconds. Then, the Control board reads air flow speed for **T19** seconds and checks if this value is in the range **FL2X±(FL2X*FL5X)** for the current System Power. If this does not happen the sensor modifies the set values for Combustion Fan and/or Auger. Regulations act on the outputs as follows:
 - *Read Air flow Speed value lower than prefixed range:*
The Combustion Fan speed has increased of **U60** up to the value **P30**.
The Auger's time work/speed has decreased of **C60** up to the value **P27** if the auger is without inverter or zero if it is with the inverter.
 - *Read Air flow Speed value higher than prefixed range:*
The Combustion Fan speed has decreased of **U60** up to the value **P14**.
The Auger's time work/speed has increased of **C60** up to the value **P05** if the auger is without inverter or 100 if it is with the inverter.

The Regulator functioning can be described into 2 modes:

 - *Single output regulation (A24=1 or 3)*
The regulator modifies the set value of one single output and if it can keep the output within defined limits, the System works normally. If output speed reaches the minimum or the maximum value, without bringing air flow speed into the limits, the system waits for a period equal to **T20** after that, if the parameter **A25** is equal to 0, the regulator continues with the current data, if **A25=1** it resets and restarts from the beginning, if **A25=2** it goes in error, disables and displays the message **Er17**, **A25=3** the system goes in Block with alarm **Er17**.
 - *Two outputs regulation (A24=2 or 4)*
The regulator modifies the set value of primary output and if it can keep the output within defined limits, the System works normally. If output speed reaches the minimum or the maximum value, without bringing air flow speed into the limits, the system waits for a period equal to **T20** after that the regulation goes on the second output. If also this regulation reaches the minimum or the maximum value, without bringing air flow speed into the limits, the system waits for a period equal to **T20** after which, if **A25=0** the regulator continues with the current data, if **A25=1** resets and restarts from the beginning, if **A25=2** fails, disables itself and displays **Er17**, **A25=3** the system goes in Block with alarm **Er17**.
4. If the Air Flow Regulator is interrupted by random events that force to change the combustion, such as Periodic Cleaning, then, when the system returns on the previous state, the regulator will wait for a period equal to **T80** before the first intervention.

- If on keyboard display appears the message **Er39** the device is damaged, the regulation is disabled and the outputs, Auger and Fan, will work with the factory settings
- If on keyboard display appears the message **Er42** the maximum air flow is exceeded (**FL40**) and the system goes in Block
- If the Air Flow Sensor is enabled to work and the time **T01** is not set to zero, if the flow recorded at the end of Check Up is less than **FL20** the system goes in Extinguishing and on display appears the message **Er41**.

NOTE: If the user changes the Auger and Fan settings with the Calibration, the regulator will consider the new values obtained as starting values for the combustion management.

The values of each power obtained from regulation are stored by the system and used as starting values for the following settings. These stored values are reset (the system will start again from the value set by the manufacturer) if the combustion recipe or the **A24** value are modified, or in the case of lack of voltage.

7.16 HYDRO - AIR MODALITY

If **P42**=0, we have a Hydro system, with water heating; if **P42**=1 we have an Air heating system, that heats Air.

7.16.1 AIR EXCHANGER FAN MANAGEMENT

If **P42**=1, you have to connect a Heating Fan working in on/off modality to connectors 7-8. It turns on if water temperature is greater than **Th19** Thermostat. For safety reasons, if it was turn off by room thermostat or an external device, it will turn on in case of temperature greater than **Th25** Thermostat.

7.16.2 PLUMBING PLANT MANAGEMENT

Setting the parameter **P26** it is possible to select the wished Plumbing Plant.

High voltage 1 Security Contact:

If the contact is opened, the system activates the pump used for the disposal of excess temperature of the water in the boiler.

Auger and Fan management when there is Domestic hot water demand:

If there is DHW demand and the system is in Run Mode and automatic management, Fan and Auger values are modified in percentage by the corresponding parameters **PA18** and **PA19**.

CONFIGURATION 0

Setting the parameter **P26** = 0 it is chosen the configuration shown in Fig.1 and in Fig.2.

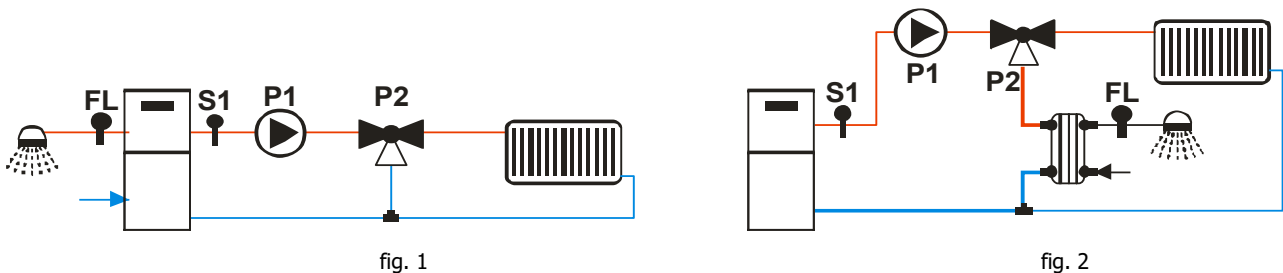

<i>Electrical Wiring:</i>	P1 = Pump Pin: 7 - 8	P2 = Sanitary Valve Pin: 22 - 24	S1 = Boiler Probe Pin: 31 - 32	FL = Flow Switch
---------------------------	--------------------------------	--	--	-------------------------

If **A41**=1 and the system is in Off state, the P1 Pump is off if there isn't a sanitary water demand and if the water temperature in the boiler is greater than **Th18** and lower than **Th21** thermostat.

Heating Plant

The Pump is on if the water temperature is greater than **Th19** Thermostat.

To avoid freezing, the Pump is on if the water temperature is below the thermostat **Th18**. If the water temperature exceeds the value of the **Th21** thermostat for safety reasons the Pump is always on.

Sanitary Plant

When there is a water demand for domestic use and the water temperature in the boiler exceeds the value of **Th19** thermostat or the water temperature in the boiler exceeds the value of the **Th20** thermostat the valve is on. If the water temperature exceeds the value of the **Th21** thermostat the valve switches to the heating plant.

Example: **Th18**=5 °C, **Th19**=40 °C, **Th20**=30 °C, **Th21**=70 °C

<i>Water Temperature</i>	<i>Flow Switch</i>	<i>Modality</i>	<i>Functioning</i>	<i>P2 Valve</i>	<i>P1 Pump</i>
T < 5°C				Heat. (OFF)	ON

$5^{\circ}\text{C} \leq T < 30^{\circ}\text{C}$				Heat. (OFF)	OFF
$30^{\circ}\text{C} \leq T < 40^{\circ}\text{C}$				DHW (ON)	ON
$40^{\circ}\text{C} \leq T < 70^{\circ}\text{C}$	open	Winter	Pellet	Heat. (OFF)	ON
		Summer	Pellet	DHW (ON)	OFF
			Wood	Heat. (OFF)	ON
	closed			DHW (ON)	ON
$T \geq 70^{\circ}\text{C}$				Heat. (OFF)	ON

CONFIGURATION 1

Setting the parameter **P26=1** it is chosen the configuration shown in Fig.3 and in Fig.4.

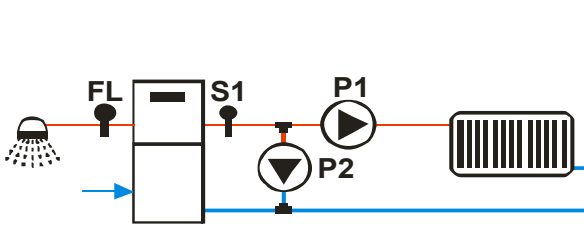

fig. 3

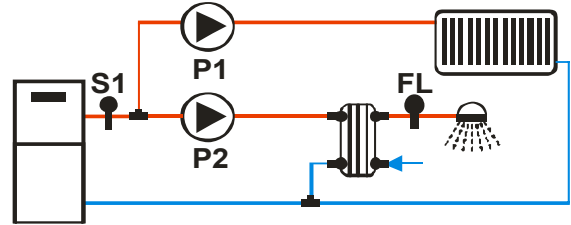

fig. 4

<i>Electrical Wiring:</i>	P1 = Pump Pin: 7 - 8	P2 = Sanitary Pump Pin: 22 - 24	S1 = Boiler Probe Pin: 31 - 32	FL = Flow Switch
---------------------------	--------------------------------	---	--	-------------------------

If **A41=1** and the system is in Off state, the P1 Pump is off if the water temperature in the boiler is greater than **Th18** and lower than **Th21** thermostat.

Heating Plant

The P1 Pump is on if the water temperature is greater than **Th19** Thermostat. When there is a demand of domestic water the Pump P1 is blocked. To avoid freezing, the Pump P1 is on if the water temperature is below the thermostat **Th18**. If the water temperature exceeds the value of the **Th21** thermostat for safety reasons the P1 Pump is always on.

Sanitary Plant

When there is a water demand for domestic use and the water temperature in the boiler exceeds the value of **Th19** thermostat or the water temperature in the boiler exceeds the value of the **Th20** thermostat the Pump P2 is on. If the water temperature exceeds the value of the **Th21** thermostat the Pump P2 is turned off.

Example: **Th18**=5 °C, **Th19**=40 °C, **Th20**=30 °C, **Th21**=70 °C

Water Temperature	Flow Switch	Modality	Functioning	P2 Pump	P1 Pump
$T < 5^{\circ}\text{C}$				OFF	ON
$5^{\circ}\text{C} \leq T < 30^{\circ}\text{C}$				OFF	OFF
$30^{\circ}\text{C} \leq T < 40^{\circ}\text{C}$				ON	OFF
$40^{\circ}\text{C} \leq T < 70^{\circ}\text{C}$	open	Winter	Pellet	OFF	ON
		Summer	Pellet		OFF
			Wood		ON
	closed			ON	OFF
$T \geq 70^{\circ}\text{C}$				OFF	ON

CONFIGURATION 2

Setting the parameter **P26=2** it is chosen the configuration shown in Fig.5.

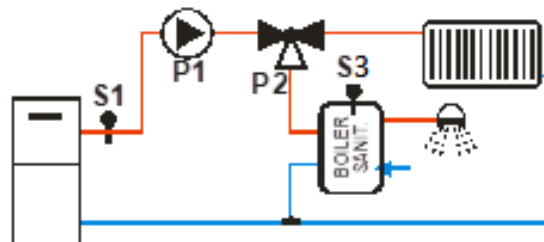

fig. 5

<i>Electrical Wiring:</i>	P1 = Pump Pin: 7 - 8	P2 = Sanitary Valve Pin: 22 - 23 - 24	S1 = Boiler Probe Pin: 31 - 32	S3 =DHW Probe
---------------------------	--------------------------------	---	--	----------------------

If **A41**=1 and the system is in Off state, the P1 Pump is off if there isn't a sanitary water demand and if the water temperature in the boiler is greater than **Th18** and lower than **Th21** thermostat.

Heating Plant

The pump P1 is on if the water temperature in the boiler exceeds the value of **Th20** thermostat and the water temperature in the buffer doesn't exceed the value of DHW Thermostat (**Th79**) and the difference between the read temperature by probe S1 and S3 probes is greater than the **Th57** thermostat.

The Pump is on if the water temperature in the boiler is greater than **Th19** Thermostat. To avoid freezing, the Pump is on if the water temperature in the boiler is below **Th18** thermostat. If the water temperature in the boiler exceeds the value of the **Th21** thermostat for safety reasons the Pump is always on.

Sanitary Plant

If buffer temperature is lower than DHW Thermostat (**Th79**) and the boiler temperature is higher than **Th20** thermostat and the differential temperature between S1 and S3 probes is over than **Th57** thermostat, the Valve P2 is on. If the boiler temperature exceeds the **Th21** thermostat's value the valve P2 is turned off.

Example: **Th18**=5 °C, **Th19**=65 °C, **Th20**=50 °C, **Th21**=70 °C, **Th57**=5 °C, **Th79**=55 °C

S1 Temp. Probe	S3 Temp. Probe	Modality	Functioning	Diff.	P2 Valve	P1 Pump
T < 5°C					Heat. (OFF)	ON
5°C ≤ T < 50°C					Heat. (OFF)	OFF
50°C ≤ T < 65°C	T < 55°C			< 5°C	Heat. (OFF)	OFF
				≥ 5°C	DHW (ON)	ON
	T > 55°C			< 5°C	Heat. (OFF)	OFF
		Winter		≥ 5°C	Heat. (OFF)	OFF
		Summer		≥ 5°C	DHW (ON)	ON
65°C ≤ T < 70°C	T < 55°C			< 5°C	Heat. (OFF)	OFF
				≥ 5°C	DHW (ON)	ON
		Wood			Heat. (OFF)	ON
	Winter	Pellet			Heat. (OFF)	ON
	Summer	Pellet	< 5°C		DHW (ON)	OFF
	Summer	Pellet	≥ 5°C		DHW (ON)	ON
T ≥ 70°C					Heat. (OFF)	ON

CONFIGURATION 3

Setting the parameter **P26**=3 it is chosen the configuration shown in fig.6.

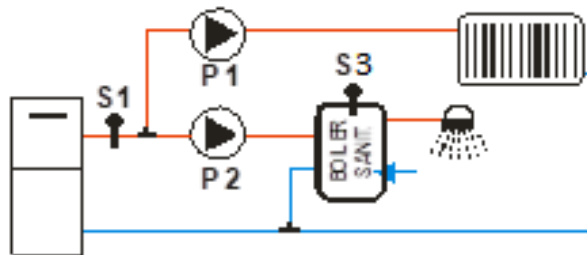

fig. 6

Electrical Wiring:	P1 = Pump Pin: 7 - 8	P2 = Sanitary Pump Pin: 22 - 24	S1 = Boiler Probe Pin: 31 - 32	S3 =DHW Probe
--------------------	--------------------------------	---	--	----------------------

If **A41**=1 and the system is in Off state, the P1 Pump is off if the water temperature in the boiler is greater than **Th18** and lower than **Th21** thermostat.

Heating Plant

The pump P1 is on above the **Th19** thermostat if the difference between the temperature read by probes S1 and S3 is less than the **Th57** thermostat or the water temperature in the buffer has reached the DHW Thermostat (**Th79**). To avoid freezing, the Pump is on if the water boiler temperature is below the **Th18** thermostat. If the water boiler temperature exceeds the value of the **Th21** thermostat for safety reasons the Pump is always on. If you do not want to block the P1 pump sanitary water demand set **A54**=1.

Sanitary Plant

The Pump P2 has to heat the water inside the sanitary tank. It will be activated only if the water temperature in the boiler exceeds the value of the thermostat **Th20** and the difference between the temperature read by probes S1 and S3 is greater than the **Th57** thermostat. If the boiler temperature exceeds the value of the **Th21** thermostat for safety reasons the Pump P2 turns off.

Example: **Th18**=5 °C, **Th19**=65 °C, **Th20**=50 °C, **Th21**=70 °C, **Th57**=5 °C, **Th79**=55 °C

S1 Temp. Probe	S3 Temp. Probe	Modality	Functioning	Diff.	P2 Pump	P1 Pump
T < 5°C					OFF	ON
5°C ≤ T < 50°C					OFF	OFF
50°C ≤ T < 65°C	T < 55°C			< 5°C	OFF	OFF
				≥ 5°C	ON	OFF

	T > 55°C			< 5°C	OFF	OFF
		Winter		≥ 5°C	OFF	OFF
		Summer		≥ 5°C	ON	OFF
65°C ≤ T < 70°C	T < 55°C			< 5°C	OFF	OFF
				≥ 5°C	ON	OFF
	T > 55°C		Wood		OFF	ON
		Winter	Pellet		OFF	ON
		Summer	Pellet	< 5°C	OFF	OFF
		Summer	Pellet	≥ 5°C	ON	OFF
T ≥ 70°C				OFF	ON	

CONFIGURATION 4

Setting the parameter **P26=4** it is chosen the configuration shown in fig.7.

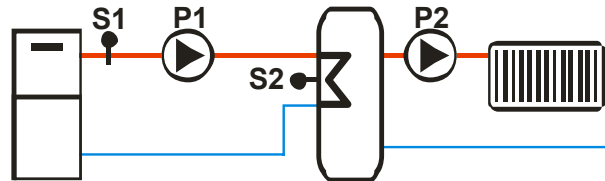

fig. 7

<i>Electrical Wiring:</i>	P1 = Pump Pin: 7 - 8	P2 = Heating plant Pump Pin: 22 - 24	S1 = Boiler Probe Pin: 31 - 32	S2 = Buffer Probe
---------------------------	--------------------------------	--	--	--------------------------

Loading Buffer

If the temperature in the boiler is greater than the **Th19** thermostat, the system heats the water in the buffer if there is differential between the two probes (S1 temperature–S2 temperature > thermostat **Th57**). If the water temperature exceeds the value of the **Th21** thermostat for safety reasons the Pump is always active. The Pump P2 turns on if the buffer temperature exceeds the thermostat **Th59** value.

Example: **Th18**= 5 °C, **Th19**=40 °C, **Th21**=70 °C, **Th57**=5 °C, **Th59**=50 °C

<i>S1 Temperature Probe</i>	<i>Differential</i>	<i>P1 Pump</i>
T < 5°C		ON
T < 40°C		OFF
T ≥ 40°C	< 5°C	OFF
	≥ 5°C	ON
T ≥ 70°C		ON

<i>S2 Temperature Probe</i>	<i>Modality</i>	<i>Functioning</i>	<i>P2 Pump</i>
T < 50°C			OFF
T ≥ 50°C	Winter		ON
	Summer	Wood	ON
	Summer	Pellet	OFF

CONFIGURATION 5

Setting the parameter **P26=5** it is chosen the configuration shown in fig.8.

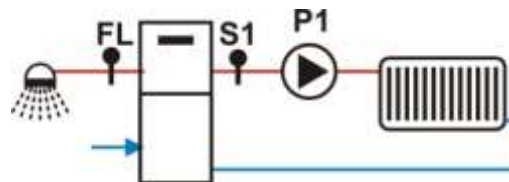

fig. 8

<i>Electrical Wiring:</i>	P1 = Pump Pin: 7 - 8	S1 = Boiler Probe Pin: 31 - 32	FL = Flow Switch
---------------------------	--------------------------------	--	-------------------------

If **A41**=1 and the system is in Off state, the P1 Pump is off if the water temperature in the boiler is greater than **Th18** and lower than **Th21** thermostat.

Heating Plant

The pump P1 is activated if the water temperature in the boiler exceeds the value of **Th19** thermostat. To avoid freezing, the Pump is On if the water temperature is below the thermostat **Th18**. If the water temperature exceeds the value of the **Th21** thermostat for safety reasons the Pump is always on.

Sanitary Plant

When there is a sanitary water demand the system stops the Pump.

The Output Aux 1 switches on if the boiler temperature exceeds the thermostat **Th56** value.

Example: **Th18**=5 °C, **Th19**=40 °C, **Th21**=70 °C

Water Temperature	Modality	Flow Switch	P1 Pump
$T < 5^{\circ}\text{C}$			ON
$5^{\circ}\text{C} < T < 40^{\circ}\text{C}$			OFF
$40^{\circ}\text{C} < T < 70^{\circ}\text{C}$	Summer		OFF
	Winter	closed	OFF
	Winter	open	ON
$T > 70^{\circ}\text{C}$			ON

CONFIGURATION 6

Setting the parameter **P26**=6 it is chosen the configuration shown in fig.9.

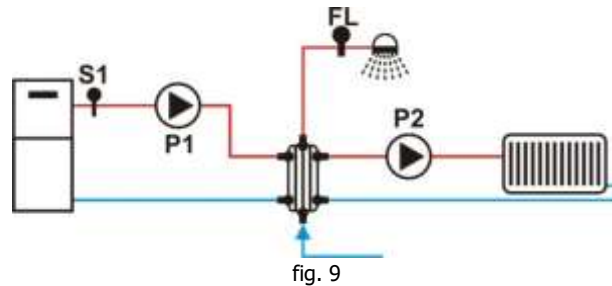

Electrical Wiring:	P1 = Boiler Pump Pin: 7 - 8	P2 = Pump Pin: 22 - 24	S1 = Boiler Probe Pin: 31 - 32	FL = Flow Switch
--------------------	---------------------------------------	----------------------------------	--	-------------------------

If **A41**=1 and the system is in Off state, the P2 Pump is off if the water temperature in the boiler is greater than **Th18** and lower than **Th21** thermostat.

Heating Plant

The pump P2 is on above the **Th19** thermostat if there isn't a sanitary water demand. To avoid freezing the water pump P2 is on if the water temperature is under the thermostat **Th18** or if it is greater than **Th21** thermostat.

Sanitary Plant

The Pump P1 is on if the water temperature is greater than thermostat **Th20**. To avoid freezing, the Pump P2 is on if the water temperature is below the thermostat **Th18**.

Example: **Th18**=5 °C, **Th19**=40 °C, **Th20**=30 °C, **Th21**=70 °C

S1 Temp. Probe	Flow Switch	Modality	Functioning	P1 Pump	P2 Pump
$T < 5^{\circ}\text{C}$				ON	ON
$5^{\circ}\text{C} \leq T < 30^{\circ}\text{C}$				OFF	OFF
$30^{\circ}\text{C} \leq T < 40^{\circ}\text{C}$				ON	OFF
$40^{\circ}\text{C} \leq T < 70^{\circ}\text{C}$	closed			ON	OFF
	open	Winter		ON	ON
		Summer	Wood	ON	OFF
		Summer	Pellet	OFF	OFF
$T \geq 70^{\circ}\text{C}$				ON	ON

CONFIGURATION 7

Setting the parameter **P26** = 7 it is chosen the configuration shown in fig.10.

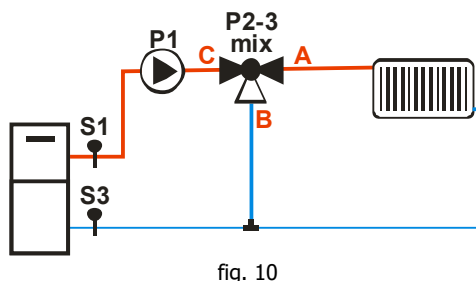

Electrical Wiring:	P1 = Pump Pin: 7 - 8	P2-3 = Mixer Valve Pin: 46 - 47	S1 = Boiler Probe Pin: 31 - 32	S3 =Return Boiler Probe
--------------------	--------------------------------	---	--	--------------------------------

If **A41**=1 and the system is in Off state, the P1 Pump is off if the water temperature in the boiler is greater than **Th18** and lower than **Th21** thermostat.

Heating

This plant manage the Mixer Valve to adjust the return temperature. (see sec. 7.13.14).

The Pump is on if the water temperature is greater than **Th19** Thermostat. To avoid freezing, the Pump is on if the water temperature is below the thermostat **Th18**. If the water temperature is greater than the value of **Th21** Thermostat, for safety reason the pump is always ON.

Example: **Th18** = 5 °C, **Th19** = 40 °C, **Th21** = 70 °C

Water Temperature	P1 Pump
$T < 5^{\circ}\text{C}$	ON
$5^{\circ}\text{C} \leq T < 40^{\circ}\text{C}$	OFF
$40^{\circ}\text{C} \leq T < 70^{\circ}\text{C}$	ON
$T \geq 70^{\circ}\text{C}$	ON

CONFIGURATION 8

Setting the parameter **P26** = **8** it is chosen the configuration shown in fig in fig.11.

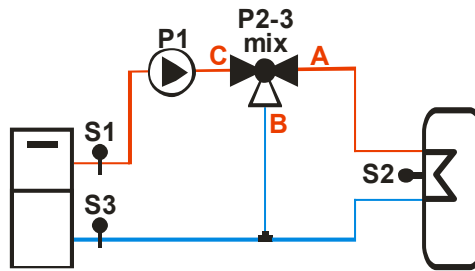

fig. 11

Electrical Wiring:	P1 = Pump Pin: 7 - 8	P2-3 = Mixer Valve Pin: 46 - 47	S1 = Boiler Probe Pin: 31 - 32	S2 = Buffer Probe Pin: 34 - 35	S3 =Return Boiler Probe
--------------------	--------------------------------	---	--	--	--------------------------------

Loading Buffer

This plant manage the Mixer Valve to adjust the return temperature. (see sec. 7.13.14).

If the temperature in the boiler is greater than the **Th19** thermostat, the system heats the water in the buffer if there is differential between the two probes (S1 temperature–S2 temperature > thermostat **Th57**). If the water temperature exceeds the value of the **Th21** thermostat for safety reasons the Pump is always active.

Example: **Th19** = 40 °C, **Th21** = 70 °C, **Th57** = 5 °C **Th59** = 40 °C

S1 Temperature Probe	Differential	P1 Pump
$T < 5^{\circ}\text{C}$		ON
$T < 40^{\circ}\text{C}$		OFF
$T \geq 40^{\circ}\text{C}$	$< 5^{\circ}\text{C}$	OFF
	$\geq 5^{\circ}\text{C}$	ON
$T \geq 70^{\circ}\text{C}$		ON

CONFIGURATION 9

Setting the parameter **P26** = **9** it is chosen the configuration shown in fig in fig.12.

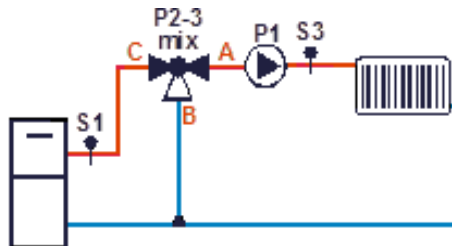

fig. 12

Electrical Wiring:	P1 =Pump Pin: 7 - 8	P2-3 = Mixer Valve Pin: 46 - 47	S1 = Boiler Probe Pin: 31 - 32	S3 =Flow Boiler Probe
--------------------	-------------------------------	---	--	------------------------------

If **A41**=1 and the system is in Off state, the P1 Pump is off if the water temperature in the boiler is greater than **Th18** and lower than **Th21** thermostat.

Heating

This plant manage the Mixer Valve to adjust the return temperature. (see sec. 7.13.14).

The Pump is on if the water temperature is greater than **Th19** Thermostat. To avoid freezing, the Pump is on if the water temperature is below the thermostat **Th18**. If the water temperature is greater than the value of **Th21** Thermostat, for safety reason the pump is always ON.

Example: **Th18** = 5 °C, **Th19** = 40 °C, **Th21** = 70 °C

Water Temperature	P1 Pump
$T < 5^{\circ}\text{C}$	ON
$5^{\circ}\text{C} \leq T < 40^{\circ}\text{C}$	OFF
$40^{\circ}\text{C} \leq T < 70^{\circ}\text{C}$	ON
$T \geq 70^{\circ}\text{C}$	ON

CONFIGURATION 10

Setting the parameter **P26** = **10** it is chosen the configuration shown in fig 13.

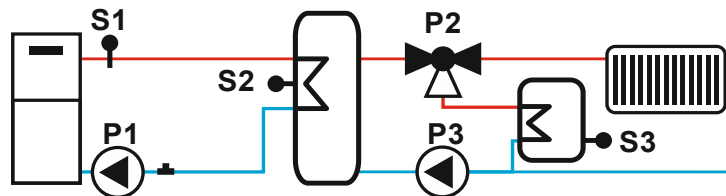

fig. 13

Electrical Wiring:	P3 =System Pump	P2 = Valve Pin: 22 - 24	P1 =Recirculation Pump Pin: 7-8	S1 =Boiler Probe Pin: 31 - 32	S2 =Buffer Probe	S3 =DHW Probe
--------------------	------------------------	-----------------------------------	---	---	-------------------------	----------------------

Antifreeze

To avoid the freeze of water, if the water temperature falls below the value of the thermostat **Th18**, the P1 and P3 pumps activate and the P2 valve changes to the plant.

Run Mode

The system heats buffer water if the temperature into the boiler is higher than the thermostat value **Th19** and if there's difference between the boiler probe and the buffer probe (boiler water temperature minus buffer water temperature, the result has to be higher than the differential thermostat **Th57**).

The system heats boiler sanitary water if the boiler sanitary thermostat (**Th79**) is not reached and if there's difference between the buffer probe and the boiler probe (buffer water temperature minus sanitary boiler water temperature, the result has to be higher than the differential thermostat **Th81**).

Once the boiler sanitary thermostat (**Th79**) is reached, if the room thermostat is not reached and the buffer water temperature is higher than the thermostat value **Th59**, the system ensures the home heating.

Over Temperature

If the boiler water temperature is higher than the thermostat values **Th21** or **Th25** for safety the P1 pump is on. If the buffer water temperature is higher than the thermostat **Th78** value, the P3 pump is on and the P2 valve changes to the sanitary boiler. If the sanitary boiler water temperature is higher than the thermostat **Th80** value, the P2 valve changes to the plant.

Example: **Th18**=5°C, **Th19**=40°C, **Th21**=75°C, **Th57**=5°C, **Th58**=60°C, **Th78**=70°C, **Th79**=55, **Th80**=65°C, **Th81**=5°C, **Th59**=50°C

Antifreeze							
T. probe S1	T. probe S2	T. probe S3	Diff. 1-2	Diff. 2-3	Pump P3	Pump P1	Valve P2
$T < 5^{\circ}\text{C}$	-	-	-	-	ON	ON	Heat. (OFF)
Run Mode							
T. probe S1	T. probe S2	T. probe S3	Diff. 1-2	Diff. 2-3	Pump P3	Pump P1	Valve P2
$T < 40^{\circ}\text{C}$	-	-	-	-	OFF	OFF	Heat. (OFF)
$T \geq 40^{\circ}\text{C}$	-	-	$>5^{\circ}\text{C}$	$\leq 5^{\circ}\text{C}$	OFF	ON	Heat. (OFF)
$T \geq 40^{\circ}\text{C}$	-	$T < 55^{\circ}\text{C}$	$>5^{\circ}\text{C}$	$>5^{\circ}\text{C}$	ON	ON	DHW (ON)
$T \geq 40^{\circ}\text{C}$	$T < 50$	$T \geq 55^{\circ}\text{C}$	$>5^{\circ}\text{C}$	-	OFF	ON	Heat. (OFF)
$T \geq 40^{\circ}\text{C}$	$T \geq 50$	$T \geq 55^{\circ}\text{C}$	$>5^{\circ}\text{C}$	-	ON	ON	Heat. (OFF)
Over Temperature							
T. probe S1	T. probe S2	T. probe S3	Diff. 1-2	Diff. 2-3	Pump P3	Pump P1	Valve P2
$T \geq 75^{\circ}\text{C}$	$T < 70^{\circ}\text{C}$	$T < 65^{\circ}\text{C}$	-	-	OFF	ON	DHW (ON)
$T < 75^{\circ}\text{C}$	$T \geq 70^{\circ}\text{C}$	$T < 65^{\circ}\text{C}$	-	-	ON	OFF	DHW (ON)
$T < 75^{\circ}\text{C}$	$T < 70^{\circ}\text{C}$	$T \geq 65^{\circ}\text{C}$	-	-	ON	OFF	Heat. (OFF)
$T \geq 75^{\circ}\text{C}$	$T \geq 70^{\circ}\text{C}$	$T \geq 65^{\circ}\text{C}$	-	-	ON	ON	Heat. (OFF)

CONFIGURATION 11

By setting the parameter **P26** = 11 you choose the configuration below.

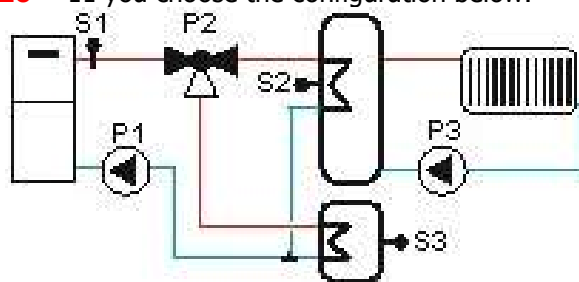

<i>Electrical Connections:</i>	P3 =System Pump	P2 = Valve Pin: 22 - 24	P1 =DHW Pump Pin: 7 - 8	S1 =Boiler Probe Pin: 31 - 32	S2 =Buffer probe	S3 = DHW Probe
--------------------------------	------------------------	--------------------------------	--------------------------------	--------------------------------------	-------------------------	-----------------------

Antifreeze

To avoid the freezing of the water, if the water temperature drops below the thermostat **Th18**, P1 and P3 pumps switch on and P2 valve switches to the Buffer.

Run Mode

The system heats the water in the DHW buffer if the temperature in the boiler exceeds the thermostat **Th19**, if ACS thermostat (**Th79**) is not reached and there is differential between boiler probe and DHW probe (boiler temperature minus water temperature in DHW Buffer greater then differential thermostat **Th97**).

Once DHW thermostat is reached (**Th79**), the system heats the water in the Buffer if there is differential between boiler probe and buffer probe (water temperature in the boiler minus water temperature in the Buffer greater then differential thermostat **Th57**).

If Ambient Thermostat is not reached and the water temperature in the Buffer is greater then the thermostat **Th59**, the system performs the heating through the pump P3.

Overheating

If the water temperature in the boiler exceeds the value of the thermostats **Th21** or **Th25** for safety reasons P1 is on.

If the water temperature in the buffer exceeds the value of **Th78** thermostat, P3 pump switches on and P2 valve switches to DHW buffer.

If the DHW buffer water temperature exceeds the value of the thermostat **Th80** P2 valve switches to the heating plant.

During Summer P3 pump is always OFF except when the buffer water temperature exceeds the value of the thermostat **Th78** and P2 valve is always directed to DHW buffer, except when DHW buffer water temperature exceeds the value of the thermostat **Th80**.

Example: **Th18**=5°C, **Th19**=40°C, **Th21**=75°C, **Th57**=5°C, **Th58**=60°C, **Th78**=70°C, **Th79**=55, **Th80**=65°C, **Th97**=5°C, **Th59**=50°C

Antifreeze

<i>T. probe S1</i>	<i>T. probe S2</i>	<i>T. probe S3</i>	<i>Diff.1-2</i>	<i>Diff. 1-3</i>	<i>Pump P3</i>	<i>Pump P1</i>	<i>Valve P2</i>
T < 5°C	-	-	-	-	ON	ON	heat. (OFF)

Run Mode

<i>T. probe S1</i>	<i>T. probe S2</i>	<i>T. probe S3</i>	<i>Diff.1-2</i>	<i>Diff. 1-3</i>	<i>Pump P3</i>	<i>Pump P1</i>	<i>Valve P2</i>
T < 40°C	-	-	-	-	OFF	OFF	heat. (OFF)
T ≥ 40°C	T < 50	T < 55°C	-	≤5°C	OFF	OFF	DHW (ON)
T ≥ 40°C	T < 50	T < 55°C	-	>5°C	OFF	ON	DHW (ON)
T ≥ 40°C	T ≥ 50	T < 55°C	-	>5°C	ON	ON	DHW (ON)
T ≥ 40°C	T < 50	T ≥ 55°C	≤5°C	-	OFF	OFF	Heat. (OFF)
T ≥ 40°C	T < 50	T ≥ 55°C	>5°C	-	OFF	ON	Heat. (OFF)
T ≥ 40°C	T ≥ 50	T ≥ 55°C	>5°C	-	ON	ON	Heat. (OFF)
T ≥ 40°C	T ≥ 50	T ≥ 55°C	≤5°C	-	ON	OFF	Heat. (OFF)

Water Overtemperature

<i>T. probe S1</i>	<i>T. probe S2</i>	<i>T. probe S3</i>	<i>Diff. 1-2</i>	<i>Diff. 2-3</i>	<i>Pump P3</i>	<i>Pump P1</i>	<i>Valve P2</i>
T ≥ 75°C	T < 70°C	T < 65°C	-	-	-	ON	heat. (OFF)
T < 75°C	T ≥ 70°C	T < 65°C	-	-	ON	ON	DHW (ON)
T < 75°C	T < 70°C	T ≥ 65°C	-	-	-	ON	heat. (OFF)
T ≥ 75°C	T ≥ 70°C	T ≥ 65°C	-	-	ON	ON	heat. (OFF)

7.16.2.1. PUMP AND VALVE ANTI-LOCK FUNCTION

If the Pump is off for the time **T42** it will switch on for the time **T41**. If the Valve is off for the time **T42** it will switch on for the time **T46**.

7.16.2.2. SANITARY FUNCTION

In the plumbing plants in which the Flow Switch is present, if there is a domestic water demand the Sanitary Function starts: the Boiler Thermostat becomes equal to the value of **Th21-Ih21** and the combustion is controlled by this value. When it is not required the Sanitary Function will stop at the end of **T68** timer. This function is disabled during the phases of ignition of wood with pellet on Combi Mode 2 (**P11=4**). If the parameter **A60=1** this function is available also for plumbing plants 2.

7.16.2.3. PRESSURE SENSOR SELECTION

Setting the parameter **P20** it is possible to select the water pressure sensor to use. If:

- **P20=0** select type A

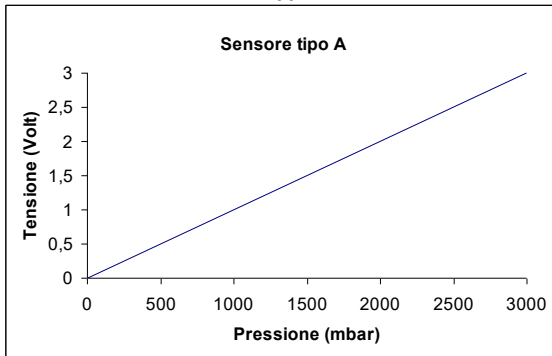

- **P20=1** select type B

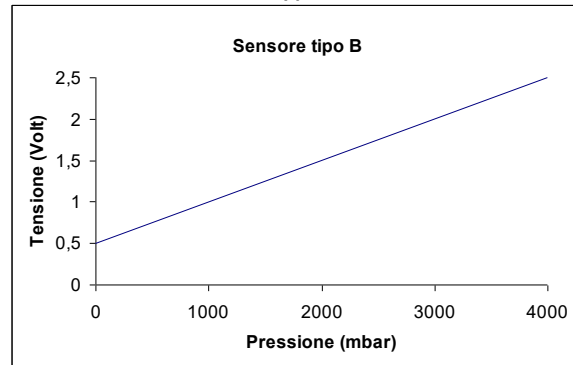

- **P20=2** select type C

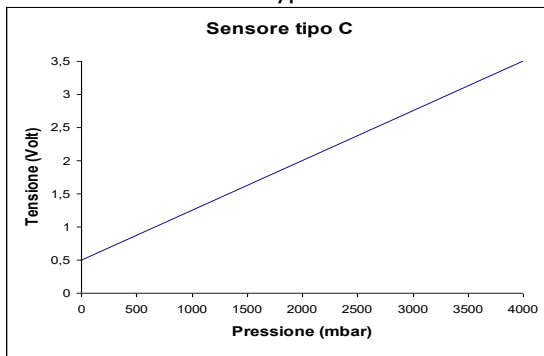

8 SYSTEM MENU PARAMETERS

8.1 AUGER MENU

In case of Encoder version (parameter **P81**=1, 2) values are expressed in RPM, if we have a without Encoder version (**P81**=1) in seconds.

The auger regulation can be set with a step of 0.1 seconds, while the speed can be set with a step of 10RPM. The set or calculated values are automatically defined between the limits **P05** and **P27**.

This menu is visible only in Pellet modality.

Code	Description	Min	Max	Unit
C01*	Ignition Power	0/ P27	3000	[RPM]
			60	[s]
C02*	Stabilization Power	0/ P27	3000	[RPM]
			60	[s]
C03*	Power 1	P27	3000	[RPM]
			60	[s]
C04*	Power 2	P27	3000	[RPM]
			60	[s]
C05*	Power 3	P27	3000	[RPM]
			60	[s]
C06*	Power 4	P27	3000	[RPM]
			60	[s]
C07*	Power 5	P27	3000	[RPM]
			60	[s]
C08*	Power 6	P27	3000	[RPM]
			60	[s]
C09*	Periodic Cleaning Power	0/ P27	3000	[RPM]
			60	[s]
C10*	Second Ignition Power	0/ P27	3000	[RPM]
			60	[s]
C11*	Modulation Power	P27	3000	[RPM]
			60	[s]
C12*	Standby Power	0/ P27	3000	[RPM]
			60	[s]
P05	Auger Period *	4	60	[s]
	Auger's maximum speed	200	3000	[RPM]
P27	Auger's minimum work time	0	60	[s]
	Auger's minimum Speed	200	3000	[RPM]
P35	Pulses for Revolution	1	4	[nr]
P57*	Maximum time reachable for Auger On	0	60	[s]

* it changes with combustion recipe

8.2 COMBUSTION FAN MENU

Menu to set the Combustion Fan's values for all functioning power; they are referred to the current combustion recipe. In the encoder version (**P25**=1), the values are in revolutions per minute, in the version without encoder (**P25**=0) they are in Volts. The set or calculated values are automatically defined between the limits **P14** and **P30**. If a value is set to zero is not brought to the **P14** value.

Code	Description	Min	Max	Unit
V01*	Ignition Power (only in Pellet modality)	P14	P30	[V]
		P14	P30	[RPM]
V02*	Stabilization Power (only in Pellet modality)	P14	P30	[V]
		P14	P30	[RPM]
V03*	Power 1	P14	P30	[V]
		P14	P30	[RPM]
V04*	Power 2	P14	P30	[V]
		P14	P30	[RPM]
V05*	Power 3	P14	P30	[V]

		P14	P30	[RPM]
V06*	Power 4	P14	P30	[V]
		P14	P30	[RPM]
V07*	Power 5	P14	P30	[V]
		P14	P30	[RPM]
V08*	Power 6	P14	P30	[V]
		P14	P30	[RPM]
V09*	Periodic Cleaning Power (only in Pellet modality)	P14	P30	[V]
		P14	P30	[RPM]
V10*	Second Ignition Power (only in Pellet modality)	P14	P30	[V]
		P14	P30	[RPM]
V11*	Modulation Power	P14	P30	[V]
		P14	P30	[RPM]
V12*	Standby Power	P14	P30	[V]
		P14	P30	[RPM]
V14	Operating power after transition from Pellet to Wood in Combi 2 modality	P14	P30	[V]
		P14	P30	[RPM]
P23*	Extinguishing Power (only in Pellet modality)	P14	P30	[V]
		P14	P30	[RPM]
P14	Minimum speed of Combustion Fan (only in Pellet modality)	0	230	[V]
		0	2800	[RPM]
P30	Maximum speed of Combustion Fan (only in Pellet modality)	0	230	[V]
		0	2800	[RPM]
P29	Pulses for Revolution	1	15	[nr]

* it changes with combustion recipe

8.3 COMBUSTION FAN 2 MENU

<i>Code</i>	<i>Description</i>	<i>Min</i>	<i>Max</i>	<i>Unit</i>
VS01*	Ignition Power (only in Pellet modality)	0	230	[V]
VS02*	Stabilization Power (only in Pellet modality)	0	230	[V]
VS03*	Power 1	0	230	[V]
VS04*	Power 2	0	230	[V]
VS05*	Power 3	0	230	[V]
VS06*	Power 4	0	230	[V]
VS07*	Power 5	0	230	[V]
VS08*	Power 6	0	230	[V]
VS09*	Periodic Cleaning Power (only in Pellet modality)	0	230	[V]
VS10*	Second Ignition Power (only in Pellet modality)	0	230	[V]
VS11*	Modulation Power	0	230	[V]
VS12*	Standby Power	0	230	[V]
VS13*	Extinguishing Power (only in Pellet modality)	0	230	[V]
VS14	Operating power after transition from Pellet to Wood in Combi 2 modality	0	230	[V]

* it changes with combustion recipe

8.4 HEATING FAN MENU

<i>Code</i>	<i>Description</i>	<i>Min</i>	<i>Max</i>	<i>Unit</i>
F01	Power 1	0	230	[V]
F02	Power 2	0	230	[V]
F03	Power 3	0	230	[V]
F04	Power 4	0	230	[V]
F05	Power 5	0	230	[V]
F06	Power 6	0	230	[V]
A03	Fan management in Modulation, Standby or if room temperature > Room Thermostat: 0=Off; 1=Power 1	0	1	[nr]
A04	Heating mode management (0>manual/automatic; 1=automatic)	0	1	[nr]
P06	Heating power management: 1=equal to combustion power;	1	3	[nr]

	2=proportional to exhaust temperature 3=proportional to room temperature			
P95	Setting minimum Heating power	0	1	[nr]
Th05	Thermostat probe for activation Heating Fan	5	900	[°C]
D04	Delta variation exhaust temperature for automatic regulation of Heating Fan (P06=2)	1	120	[°C]
D05	Delta room temperature for automatic regulation of the heating power.	3	30	[°C]
T69	Delay for Heating Fan at the maximum speed if flue gas temperature > Thermostat Th07	0	900	[s]

8.5 THERMOSTATS MENU

Code	Description	Probe	Min	Max	Unit
L00	Light's Thermostat for system off in pellets modality	Photoresist	0	100	[n.r.]
IL00	Thermostat L00 Hysteresis	Photoresist	0	20	[n.r.]
L01	Light's Thermostat for bypass on in pellets modality	Photoresist	0	100	[n.r.]
IL01	Thermostat L01 Hysteresis	Photoresist	0	20	[n.r.]
Th01	Stove off	Exhaust	5	900	[°C]
Th02	Resistance switch off	Exhaust	5	900	[°C]
Th03	Pre-Extinguishing thermostat for low flue gas temperature	Exhaust	5	900	[°C]
Th06	Thermostat to go in Stabilisation from Variable Ignition	Exhaust	5	900	[°C]
Th07*	Exhaust Modulation	Exhaust	5	900	[°C]
Ih07*	Th07 Thermostat Hysteresis	Exhaust	2	50	[°C]
Th08*	Exhaust Safety	Exhaust	5	900	[°C]
Ih08*	Th08 Thermostat Hysteresis	Exhaust	2	50	[°C]
Th09	Bypass Ignition	Exhaust	5	900	[°C]
Th13	Stove off in Wood modality	Exhaust	5	900	[°C]
Th15	Air Valve 3 Activation (if P48 , P44 or P36=20)	Exhaust	5	900	[°C]
Th18	Ice Thermostat	Boiler	5	350	[°C]
Th19	Activation Pump Thermostat	Boiler	20	350	[°C]
Ih19	Activation Pump Thermostat Hysteresis	Boiler	1	20	[°C]
Th20	Sanitary 1 Thermostat	Boiler	20	350	[°C]
Th21	Sanitary 2 Thermostat	Boiler	20	350	[°C]
Ih21	Water Boiler Thermostat Hysteresis 2	Boiler	1	20	[°C]
Ih24	Water Boiler Thermostat Hysteresis	Boiler	1	20	[°C]
Th25	Boiler Safety Thermostat	Boiler	20	350	[°C]
Th26	Boiler Thermostat minimum range	Boiler	20	350	[°C]
Th27	Boiler Thermostat maximum range	Boiler	20	350	[°C]
Th28*	Exhaust temp. control in Standby (in Wood mode it's not used)	Exhaust	5	900	[°C]
Ih33	Room Thermostat Hysteresis	Room	0	10	[°C]
Th35	Extinguishing Thermostat for Power 1	Exhaust	5	900	[°C]
Th36	Extinguishing Thermostat for Power 2	Exhaust	5	900	[°C]
Th37	Extinguishing Thermostat for Power 3	Exhaust	5	900	[°C]
Th38	Extinguishing Thermostat for Power 4	Exhaust	5	900	[°C]
Th39	Extinguishing Thermostat for Power 5	Exhaust	5	900	[°C]
Th40	Extinguishing Thermostat for Power 6	Exhaust	5	900	[°C]
Th43	Extinguishing Thermostat for Modulation Power	Exhaust	5	900	[°C]
Th51	Buffer Thermostat minimum range	Buffer	20	110	[°C]
Th52	Buffer Thermostat maximum range	Buffer	20	110	[°C]
Th56	Thermostat to control Aux2, Aux3 and V2 Outputs (if P48 or P36 or P44=3)	Boiler	20	350	[°C]
Ih56	Th56 Thermostat Hysteresis	Boiler	1	20	[°C]
Th57	Differential Thermostat Boiler Probe – Buffer Probe	Diff.	1	30	[°C]
Ih57	Differential Thermostat Hysteresis	Diff.	1	5	[°C]
Ih58	Buffer Thermostat Hysteresis	Buffer	1	20	[°C]
Th59	Enable P2 Pump Thermostat (only if P26=4, 10, 11)	Buffer	20	110	[°C]
Ih59	Thermostat Th59 Hysteresis (only if P26=4, 10, 11)	Buffer	1	20	[°C]
Th60	Boiler Return Thermostat (only if P26=7, 8)	Ret. Boiler	20	110	[°C]

Ih60	Boiler Return Thermostat Hysteresis (only if P26 =7, 8)	Ret. Boiler	1	20	[°C]
Th63	Pre-Extinguishing thermostat for low flue gas temperature in Combi Mode 2	Exhaust	5	900	[°C]
Th64	Wood Thermostat on Combi Mode 2	Exhaust	5	900	[°C]
Th66	Bypass variable ignition thermostat on Combi Mode 2	Exhaust	5	900	[°C]
Th68	Switch to Pellet at Wood thermostat on Combi Mode 2	Exhaust	5	900	[°C]
Th69	Bypass ignition thermostat on Combined Mode 2	Exhaust	5	900	[°C]
Ih70	Flow Thermostat Hysteresis	Flow	1	20	[°C]
Th71	Flow Max Thermostat	Flow	20	110	[°C]
Th72	Flow Max Thermostat	Flow	20	110	[°C]
Th78	Safety Buffer Probe Thermostat	Buffer	20	110	[°C]
Ih79	DHW Probe Thermostat Hysteresis	DHW	1	20	[°C]
Th80	Safety DHW Probe Thermostat	DHW	20	110	[°C]
Th81	Difference Buffer Probe – DHW Probe	Diff. 2	1	30	[°C]
Ih81	Differential 2 Thermostat Hysteresis	Diff. 2	1	5	[°C]
Th83	DHW Thermostat maximum range	DHW	20	110	[°C]
Ih85	Bottom Buffer Thermostat Hysteresis	Bottom Buffer	1	20	[°C]
Th97	Boiler Probe-DHW Probe Differential	Diff. 3	1	30	[°C]
Ih97	Differential Thermostat 3 Hysteresis	Diff. 3	1	5	[°C]
D01	Stabilization delta	-	0	100	[°C]
D08	Water delta for power modulation in automatic combustion management	-	1	30	[°C]
D11	Delta to add to Boiler Thermostat if P26 =4, 8, 10	-	1	30	[°C]
D23	Water Delta to add to the Boiler Thermostat to go in Standby from Modulation at the end of T43 if A13 =1	-	0	50	[°C]
D40	Delta to add to boiler return temperature for the fast closure of Mixer Valve	-	10	90	[°C]
D41	Ignition Delta	-	0	100	[°C]

* it changes according to combustion recipes.

NOTE:

The thermostats are considered by the system in the following way:

- *during increasing temperature*: the system considers the value of the thermostat (Ex: if **Th19**=40 °C, the system turns on the pump when the boiler water temperature exceeds 40 °C)
- *during decreasing temperature*: the system considers the value of the thermostat decreased by the value of its hysteresis (Ex: if **Th19**=40 °C and **Ih19**=2 °C the system turns off the pump when the boiler water temperature drops below **Th19-Ih19**-1=40-2-1=37 °C)

The Extinguishing Thermostats (**Th35**÷**Th43**) works as: set the thermostat's value for each combustion power, if the flue gas temperature falls below this value for the corresponding power, the system goes in Extinguishing for no flame (**Er03**).

8.6 TIMERS MENU

Code	Description	Min	Max	Unit
T01*	Check Up cleaning (in Wood modality it isn't used)	0	900	[s]
T02*	Preheating phase (in Wood modality it isn't used)	0	900	[s]
T03*	Auger Preload (in Wood modality it isn't used)	0	900	[s]
T04*	Fixed Ignition (in Wood modality it isn't used)	0	3600	[s]
T05*	Variable Ignition (in Wood modality it isn't used)	0	3600	[s]
T06*	Stabilization (in Wood modality it isn't used)	0	900	[s]
T07	Periodic cleaning cycle	15	600	[min]
T08	Periodic cleaning duration	0	900	[s]
T09	High Voltage 1 (Safety Thermostat) delay	1	900	[s]
T10	High Voltage 2 (Pressure switch) delay	1	900	[s]
T11	Exit from Standby delay	0	900	[s]
T13	Minimum period time of extinguishing	0	900	[s]
T14	Waiting time pre-extinguishing for no flame	0	900	[s]
T15	Waiting time pre-extinguishing in Safety	0	900	[s]
T16	Final cleaning time	0	900	[s]
T17	Delay time combustion power change	0	900	[s]

T18	Delay time combustion power change in exit from Ignition	0	900	[s]
T21	"Combi" function disable: Delay to turn off the system if the exhaust temperature in Wood modality is lower than Th13 Thermostat "Combi" function enable: Delay to restart the system in Pellet modality	0	60	[min]
T22	Delay time to enter in Standby	0	900	[s]
T23	Pellet tank charging time over minimum level	0	3600	[s]
T24	Length signalling of fuel lack if P44 , P48 or P36 are different from two, or Pellet tank charging time over minimum level if P44 , P48 or P36 are two	0	3600	[s]
T25	Working time of Exhaust Fan at V14 and Exhaust Fan 2 at VS14 after transition from Pellet to Wood in Combi 2 modality	0	60	[min]
T27	Delay to disable the Auger 2 (if P44 or P48 or P36 =17)	0	900	[s]
T29*	Timer auger off in Preload	0	900	[s]
T30	Work time of Cleaning Engine (if P44 or P48 or P36 =4)	0	9600	[s]
T31	Wait time of Cleaning Engine (if P44 or P48 or P36 =4)	1	600	[min]
T32*	Wait time to maintain the brazier in Standby	1	500	[min]
T33*	Work time to maintain the brazier in Standby	0	900	[s]
T40	Delay to enable Auger (if P44 or P48 or P36 =1)	0	900	[s]
T41	Work time of Pump if T42 is finished	0	3600	[s]
T42	Maximum idle time of Pump and Valve	1	1500	[ore]
T43	Delay to go in Standby from Modulation if boiler temperature > (Boiler Thermostat + D23) and A13 =1	0	3600	[s]
T46	Work time of Valve if T42 is finished	0	3600	[s]
T50	Auger Advancement time at the end of extinguishing	0	900	[s]
T53	Waiting time for Auger feed in Wood modality	1	500	[min]
T54	Auger's working time in Wood modality	0	900	[s]
T57*	Minimum time of extinguishing in Standby (in Wood modality it isn't used)	0	900	[s]
T58*	Final cleaning of brazier in Standby (in Wood modality it isn't used)	0	900	[s]
T66	Working time of the system before it goes in Block with the message 'Service'	0	20000	[ore]
T67	Working time of the system before appears the message 'Cleaning'	0	20000	[ore]
T68	Delay to restore the value of Boiler Thermostat if there isn't sanitary request (for plant 0, 1, 3, 5, 6)	0	900	[s]
T71	Wait time to passing Th64 thermostat in Combi2 Modality	1	500	[min]
T75	Work time of Cleaning Engine 2 (if P44 or P48 or P36 =13)	0	9600	[s]
T76	Wait time of Cleaning Engine 2 (if P44 or P48 or P36 =13)	1	600	[min]
T81	Work time for a single step of Mixer Valve (if P36 =23)	1	900	[s]
T82	Opening/closure time of Mixer Valve (if P36 =23)	1	900	[s]
T83	Waiting time for 2 regulation of Mixer Valve (if P36 =23)	1	900	[s]
T84*	Work time before the system automatically switches off (not used in Wood modality)	1	9600	[min]
T85	Maximum time for limit switch opening	1	900	[s]
T86	Work time for Brazier Cleaning Engine if P44 or P48 or P36 =25 in Extinguishing, Ignition Recovery, Standby-Extinguishing (not used in Wood modality)	0	9600	[s]
T87*	Wait time for Brazier Cleaning Engine if P44 or P48 or P36 =25 (not used in Wood modality)	1	900	[min]
T88	Maximum time of supply voltage lack for the system to go in the state it was before	10	900	[s]
T89	Maximum time of supply voltage lack for the system to go in Recover Ignition state	1	1400	[min]
T90	Air Valve 3 activation delay (if P48 =20 or P44 =20 or P36 =20)	0	250	[s]
T99	Return Time/ Cleaning Brazier Engine end of the cycle	0	9600	[s]
T100	Return Time/ Cleaning Engine 1 end of the cycle	0	9600	[s]
T101	Return Time/Cleaning Engine 2 end of the cycle	0	9600	[s]
T103	Waiting time at half cycle of Cleaning Brazier Engine	0	9600	[s]
TM11	Work time for Brazier Cleaning Engine for closing the limit switch if P44 =33 and P48 or P36 =25 (not used in Wood modality)	0	9600	[s]
TM18	Length of the extinguishing phase in Ignition Recover in case of 'Automatic Switch off' function if A40 =2	1	900	[s]
TM41	Brazier Cleaning Engine work time if P44 , P48 or P36 =25 in Run Mode	0	9600	[s]

	for Power 1 (not used in Wood modality)			
TM42	Brazier Cleaning Engine work time if P44 , P48 or P36 =25 in Run Mode for Power 2 (not used in Wood modality)	0	9600	[s]
TM43	Brazier Cleaning Engine work time if P44 , P48 or P36 =25 in Run Mode for Power 3 (not used in Wood modality)	0	9600	[s]
TM44	Brazier Cleaning Engine work time if P44 , P48 or P36 =25 in Run Mode for Power 4 (not used in Wood modality)	0	9600	[s]
TM45	Brazier Cleaning Engine work time if P44 , P48 or P36 =25 in Run Mode for Power 5 (not used in Wood modality)	0	9600	[s]
TM46	Brazier Cleaning Engine work time if P44 , P48 or P36 =25 in Run Mode for Power 6 (not used in Wood modality)	0	9600	[s]
TM47	Brazier Cleaning Engine work time if P44 , P48 or P36 =25 in Modulation (not used in Wood modality)	0	9600	[s]
TM48	Brazier Cleaning Engine work time if P44 , P48 or P36 =25 in Standby-Maintenance (not used in Wood modality)	0	9600	[s]

* it changes with combustion recipes

8.7 ENABLE MENU

<i>Code</i>	<i>Description</i>	<i>Min</i>	<i>Max</i>	<i>Unit</i>
A01	Room Thermostat management: 0=Ignition/Extinguishing; 1=Run Mode/Modulation; 2=Run Mode/Standby-Extinguishing; 3=Pump block; 4=Run Mode/Standby and Pump block; 5=Run Mode/Modulation in Wood mode and Run Mode/Standby-Extinguishing in Pellet mode; 6=Run Mode/Modulation in Wood mode and Pump block in Pellet mode; 7=Run Mode/Modulation in Wood mode and Run Mode/Standby-Extinguishing and Block Pump in Pellet mode	0	7	[nr]
A10	Ignition from Extinguishing command: 0=the system goes in Ignition Recover; 1=the system goes in Check Up	0	1	[nr]
A13	System management for Boiler thermostat reached: 0=the system goes in Modulation; 1=the system goes, firstly in Modulation and then, if boiler temperature > (Boiler Thermostat+ D23), goes in standby; 2=in Winter modality the system goes in Modulation, in Summer modality the system goes in Modulation, then if boiler temperature > (Boiler Thermostat+ D23) it goes in Standby	0	2	[nr]
A14	Error Pressure Sensor management: 0=disabled; 1=enabled	0	1	[nr]
A26	Exit from Standby when don't subsist the entering conditions: 0=at the end of T11 from any sub-phase; 1=at the end of T11 from Wait sub-phase	0	1	[nr]
A27	Standby modality management: 0=the system gets the extinguishing of brazier; 1=the system gets the maintenance of brazier	0	1	[nr]
A28	Auger brake management: 0=disabled; 1=enabled	0	1	[nr]
A29	System in Standby for Room Thermostat management: 0=stay in Standby if a sanitary water demand occurs; 1=exit from Standby if a sanitary water demand occurs	0	1	[nr]
A32	Internal chrono management: 0=Ignition/Extinguishing; 1=Run Mode/Modulation; 2=Run Mode/Standby; 3=Pump block; 4=Run Mode/Standby and Pump block	0	4	[nr]
A36	Combustion power change in Wood modality: 0=disabled and Combustion Fan Off; 1=enabled	0	1	[nr]
A40	Automatic switch off management	0	2	[nr]
A41	Pump functioning: 0=independent from states of the system; 1=off in Off state	0	1	[nr]
A44	System with one Auger only, not Safety Valve and flame return management: 0=Auger On; 1=Auger Off	0	1	[nr]
A45	Standby management for hydraulic plants 0 and 1 and Summer Mode and no sanitary water demand: 0=the system does not go into Standby; 1=the system goes into Standby	0	1	[nr]
A49	Enabling Buffer Thermostat in Wood Modality	0	1	[nr]
A51	Enabling Er02 management in Wood Modality	0	1	[nr]

A52	Room Thermostat of Remote Keyboard management: 0=menu disabled; 1=Run Mode/Modulation; 2=Run Mode/Standby-Extinguishing; 3=Pump block; 4=Run Mode/Standby and Pump block; 5=Run Mode/Modulation in Wood mode and Run Mode/Standby-Extinguishing in Pellet mode; 6=Run Mode/Modulation in Wood mode and Pump block in Pellet mode; 7=Run Mode/Modulation in Wood mode and Run Mode/Standby-Extinguishing and Block Pump in Pellet mode	0	7	[nr]
A53	Supply voltage lack management: 0=system in Block state with Er15 if there was a supply voltage lack for a time greater than T89 minutes; 1=system in Recover Ignition if there was a supply voltage lack for a time greater than T89 minutes	0	1	[nr]
A54	Sanitary priority if 26 =1 or 3: 0=sanitary has priority on the heating; 1=sanitary and heating are activated together	0	1	[nr]
A57	Additional module management: 0=not present and input IN7 (pin 40-41-42) used for Fan encoder, 1=not present and input IN7 (pin 40-41-42) used for Auger encoder, 2=present and IN7 (pin 40-41-42) used for Auger encoder and pin 51-52-54 used for Fan encoder; 3=present and input IN7 (pin 40-41-42) used for Fan encoder	0	3	[nr]
A60	Sanitary function management: 0=only for plants with flow switch; 1=also for plants 2, 3	0	1	[nr]
A61	Periodic Cleaning management: 0=only Run Mode; 1=in Modulation also	0	1	[nr]
A64	Combustion Fan and Auger calibration management: 0=disabled; 1=enabled	0	1	[nr]
A67	Management of Combustion Fan during brazier cleaning in extinguishing phase: 0=Off; 1=maximum power	0	1	[nr]
P02	Maximum number ignition attempts	1	5	[nr]
P03	Work Combustion Powers' number	1	6	[nr]
P04	Recipe number	1	2	[nr]
P09	Pellet Sensor configuration (0=input N.C.; 1=input N.O.)	0	1	[nr]
P11	Operation Configuration: 0=Pellet, 1=Wood, 2=Pellet/Wood, 3=Combi 1, 4=Combi 2	0	4	[nr]
P15	Value of the On values correcting step (if P81 =0) or of the Auger Speed (if P81 =1, 2)	1	20	[%]
P16	Correctional step value(only in Pellets functioning)	1	20	[%]
P20	Pressure Boiler Water sensor configuration (see sec.7.16.2.3)	0	2	[nr]
P25	Combustion Fan management: 0= No Encoder fan; 1=Fan with Encoder; 2=Fan with Encoder, passing automatically to P25 =0 in case of lost encoder signal (Alarm Er07)	0	2	[nr]
P26	Plumbing system management (see section 7.16)	0	11	[nr]
P36	Output Aux 3 management (pin 46-47 see section 3.1)	0	26	[nr]
P37	Management of Flame presence detection in pellets modality: 1=photoresistance only; 2=thermocouple+photoresistance	1	2	[nr]
P42	Hydro/Air configuration: 0=Hydro; 1=Air	0	1	[nr]
P44	Output V2 management (pin 5-6: see section 3.1)	0	26	[nr]
P48	Output Aux 2 management (pin 19-20-21: see section 3.1)	0	33	[nr]
P49	Cleaning cycles of Brazier Cleaning Engine when the system has reached the final power	0	100	[nr]
P50	Cleaning cycles of Brazier Cleaning Engine in the extinguishing of the brazier phase	0	100	[nr]
P51	Brazier Cleaning Engine cleaning cycles in Check Up phase	0	100	[nr]
P60	Climatic curve coefficient	0	5.0	[nr]
P70	Input IN9 management (pin 48-49-53 see section 3.1)	0	12	[nr]
P71	Input IN8 management (pin 50-51-53: see section 3.1)	0	3	[nr]
P72	Increasing percentage of Auger 2 time On respect to Auger 1 time On (if P44 =16)	0	500	[%]
P73	Input IN10 management (pin 48-49-53 see section 3.1)	0	18	[nr]
P74	Input IN2 management (pin 27-28: see section 3.1)	0	23	[nr]
P75	Input IN3 management (pin 29-30: see section 3.1)	0	23	[nr]
P76	Input IN5 management (pin 33-34-35: see section 3.1)	0	23	[nr]
P79	Number of cleaning cycles for Cleaning Engine 2	0	100	[nr]

P80	Number of cleaning cycles for Cleaning Engine	0	100	[nr]
P81	Auger Management: 0=without encoder; 1=with encoder; 2=with automatic encoder. If P81 =1 the system works with encoder management. In case of failed adjustment or signal lack, the system blocks with Er47 and Er48 errors. If system blocks with Er47 error, resetting the alarm the system can work again in P81 =0 modality	0	2	[nr]
P86	Service Function management: 0=the system doesn't go in Block state at the end of T66 , 1=the system goes in Block state at the end of T66	0	1	[nr]
P96	Door Sensor management:	0	4	[nr]
	<i>Parameter Value</i>	<i>Exhaust Fan</i>		<i>Exhaust Fan 2</i>
	0	Off		Off
	1	maximum speed		Off
	2	Off		maximum speed
	3	maximum speed		maximum speed
4	(PA46* P30)/100		(PA47* maximum speed)/100	
PA18	Percentage Variation of the combustion fan speed if there is DHW request	-100	100	[%]
PA19	Percentage Variation of the Auger Speed/On time if there is DHW request	-100	100	[%]
PA23	T71 Timer and Door management in order to switch to Wood mode	0	1	[nr]
PA29	Power for transition to Wood in Combi 2 modality	0	6	[nr]
PA41	At the system ignition the default parameters for Auger and Combustion Fan are used	0	1	[nr]
PA44	NTC probe type for input IN4: 0=NTC10K; 1=NTC231K	0	1	[nr]
PA46	Percentage to set the Combustion fan speed in case of open door and P96 =4 (see P96)	0	100	[%]
PA47	Percentage to set the Combustion fan 2 speed in case of open door and P96 =4 (see P96)	0	100	[%]
PA53	Loading Engine management in Night Mode: 0= normal operation; 1=Off	0	1	[nr]
PA54	Cleaning Engine management in Night Mode: 0= normal operation; 1=Off	0	1	[nr]
PA55	Cleaning Engine 2 management in Night Mode: 0= normal operation; 1=Off	0	1	[nr]
PA56	Brazier Cleaning Engine management in Night Mode: 0= normal operation; 1=Off	0	1	[nr]
PA62	Cleaning Engine cleaning cycles in brazier extinguishing phase	0	100	[nr]
PA63	Cleaning Engine cleaning cycles in Check up phase	0	100	[nr]
PA64	Cleaning Engine 2 cleaning cycles in brazier extinguishing phase	0	100	[nr]
PA65	Cleaning Engine 2 cleaning cycles in Check up phase	0	100	[nr]
TS01	Exhaust Probe Calibration Factor	-20	20	[%]
TS02	Water Boiler Probe Calibration Factor	-20	20	[%]

8.8 PRIMARY AIR FLOW SENSOR MENU

Menu to set the Air Flow Sensor parameters; it is visible only in Pellet modality, all combustion parameters are referred to the current Recipe. It has 3 submenu:

1. Enable

<i>Code</i>	<i>Description</i>	<i>Min</i>	<i>Max</i>	<i>Unit</i>
A24	Sensor management: 0=disabled; 1=Combustion Fan regulation; 2=Combustion Fan + Auger regulation; 3=Auger regulation; 4=Auger + Combustion Fan regulation	0	4	[nr]
A25	Regulation error management: 0=the system does nothing; 1=regulator resets and restarts regulation; 2=regulator disabled; 3=system in Block with error Er17	0	3	[nr]
A31	Regulation Outputs management: 0= regulator goes back to the last output; 1= regulator always works on the last output	0	1	[nr]
T19	Waiting time for stabilization of regulation of first output	5	900	[s]
T20	Waiting time for stabilization of regulation of second output	10	900	[s]
T80	Waiting time for first regulation	0	900	[s]
V60	Combustion Fan Regulation Step	2	100	[V]
		10	500	[RPM]
C60	Auger Regulation Step	0,1	20	[s]

		10	500	[%]
--	--	----	-----	-----

2. Air Flow Range

Code	Description	Min	Max	Unit
FL20	Minimum air flow in Check Up	0	2000	-
FL22	Set Air Flow for Power 1	0	2000	-
FL23	Set Air Flow for Power 2	0	2000	-
FL24	Set Air Flow for Power 3	0	2000	-
FL25	Set Air Flow for Power 4	0	2000	-
FL26	Set Air Flow for Power 5	0	2000	-
FL27	Set Air Flow for Power 6	0	2000	-
FL30	Set Air Flow in Modulation	0	2000	-
FL40	Maximum air flow	0	2000	-

3. Air Flow Delta Regulation

Code	Description	Min	Max	Unit
FL52	Air Flow Delta Range for Power 1	0	100	[%]
FL53	Air Flow Delta Range for Power 2	0	100	[%]
FL54	Air Flow Delta Range for Power 3	0	100	[%]
FL55	Air Flow Delta Range for Power 4	0	100	[%]
FL56	Air Flow Delta Range for Power 5	0	100	[%]
FL57	Air Flow Delta Range for Power 6	0	100	[%]
FL60	Air Flow Delta Range for Modulation	0	100	[%]

8.9 WATER PRESSURE SENSOR THRESHOLD MENU

Code	Description	Min	Max	Unit
SP01	Minimum Pressure Sensor threshold	50	4000	[mbar]
SP08	Maximum Pressure Sensor threshold	50	4000	[mbar]

8.10 COUNTERS MENU

Menu that allows the control of the counters useful for the diagnosis of the system's life.

Submenu	Description
Total time	Total time system feeding
Functioning time	Activity time system: time at least one Fan works
Operating work time	System real heating time: time in which heating is effectively produced (Run Mode and Modulation)
Ignitions' Numbers	Number of done ignition attempts
Failed Ignitions' Numbers	Number of failed ignition attempts
Errors' Numbers	Number of errors occurred.
Counters Reset	Reset all counters: turn to zero all counters
Reset Service	Menu to reset the "System Maintenance 1" function

8.11 OUTPUT'S TEST MENU

Menu that allows to test the Outputs (and the connected loading) with the system in **Off** state. The Outputs, if enabled, will stop after 30 seconds.

Submenu	Description
Combustion Fan	Combustion Fan test
Output V2	Output V2 test
Auger	Auger test
Heating Resistance	Heating Resistance test
Pump	Pump test
Valve	Valve test
Output Aux 2	Output Aux2 test
Output Aux 3	Output Aux3 test

During the Combustion Fan test, the display shows the set value [V] or [RPM] and the RPM of the fan detected by the encoder (if is present): so it is possible to create a conversion table [RPM]/[V] to use for the passage from encoder mode **P25=1** to not encoder mode **P25=0** in case of encoder breakage.

To test the Brazier Cleaning Engine managed by 2 outputs (**P48**=33 and **P44** or **P36**=25), activate V2 or Aux3 outputs; the test will make a complete cycle if not interrupted.

8.12 RESTORE PARAMETER'S FACTORY VALUE MENU

This feature allows to save the parameters set by the manufacturer as the default parameters, to be restored in case the local welfare or installers have made changes that lead to abnormal functioning of the boiler or stove.

To set the default parameters, use System Evolution Software and set the parameter "*Default parameters Restore*" to 1.